

A scenic landscape featuring a dirt road that curves through a field of tall grass. On the left, a rustic wooden fence runs along the edge of the field. In the background, several trees are visible under a cloudy, overcast sky. The overall atmosphere is misty and serene.

Trituradoras hidráulicas
para excavadoras

Hydraulic mulchers
for excavators

Broyeurs hydrauliques
pour minipelles

TFVLHC • TARIM



TRITURADORA LIGERA DE MARTILLOS O CUCHILLAS CON MOTOR HIDRÁULICO PARA MINIEXCAVADORA DE 1,5 A 3 TON. PARA TRONCOS HASTA Ø3CM

Trituradora TFVLHC de martillos o cuchillas con motor hidráulico para miniexcavadoras de 1,5 a 3 Tn. Para ramas de hasta 3 cm. Enganche para adaptación a miniexcavadoras. El bastidor de la máquina es de chapa de alto límite elástico HARDOX.

LIGHT-WEIGHT MULCHER WITH SWINGING HAMMERS OR FLAILS AND WITH AN HYDRAULIC PUMP TO FIT MINI-EXCAVATOR FROM 1,5 TO 3 TON. FOR LOGS UP TO Ø3CM

T.F.V.L.H.C. mulcher with hammers or flails. Equipped with an hydraulic pump. Suitable for excavators from 1,5 to 3 Tn. For branches up to 3 cm. Attachment for mini excavators. The machine frame is made of HARDOX high strength sheet metal.















BROYEUR LEGÈRE À MARTEAUX OSCILLANTS OU LAMES AVEC MOTEUR HYDRAULIQUE POUR L'ACCOUPLÉMENT SUR MINI-PELLES DU 1,5 A 3 TON. POUR TRONCS JUSQU'À Ø3CM

Broyeur TFVLHC avec marteaux ou lames. Équipé avec moteur hydraulique pour minipelles du 1,5 à 3 Tn. Pour branches jusqu'à 3 cm de diamètre. Pièces de fixation sur mini-pelles. Le châssis de la machine est fabriqué en tôle HARDOX à haute résistance.



Equipamiento de serie | Standard equipment |
Équipement standard

Modelos | Model | **Modèle**

			TFVLHC 60	TFVLHC 80	TFVLHC 100
	Peso excav. Weight excav. Poids Pelle	Tn / lb	1,5 - 3 / 3.307 - 6.614	1,5 - 3 / 3.307 - 6.614	1,5 - 3 / 3.307 - 6.614
	Ancho trabajo Working Width Largeur travail	cm / inch	60 / 24	80 / 31	100 / 39
	Medidas exteriores Outer dimensions Mesures extérieures	A cm / inch B cm / inch C cm / inch	48 / 19 82 / 32 58 / 23	48 / 19 102 / 40 58 / 23	48 / 19 122 / 48 58 / 23
	Ø Rotor con martillos Ø Rotor with hammers Ø Rotor avec marteaux	cm / inch	30 / 12	37 / 15	37 / 15
	Ø máx. tronco Ø máx. trunc Ø max. tronc	cm / inch	3 / 1,2	3 / 1,2	3 / 1,2
	Martillos Hammers Marteaux oscillants	Nº	10	9	10
	Cuchilla Blades Lames	Nº	-	18	20
	Peso Weight Poids	kg / lb	120 / 265	152 / 335	180 / 397
	Caudal aceite Oil flow Débit d'huile	l / gpm	25 - 35 / 7 - 9	35 - 45 / 9 - 12	35 - 45 / 9 - 12
	Presión Pressure Pression	BAR / PSI	180 - 200 / 2.611 - 2.901	150 - 180 / 2.175 - 2.011	150 - 180 / 2.175 - 2.011
	Protección trasera Rear protection Protection arrière			Cadena Chain Chaîne	
	Protección delantera Front guard Protection frontal			Goma Rubber Gomme	
	Rodillo regulable altura Roller height adjust Rouleau réglable en hauteur		NO	De serie Standard De sérié	
	Patín protec. chasis Skids chasis protec. Patins protec chasis			De serie Standard De sérié	



Equipamiento de serie | Standard equipment | Équipement standard

Latiguillos incluidos | Hoses included | **Fléxibles inclus**

Opciones | Options | Options

Eganche adaptación a miniexcavadora |

Attachment for mini-excavator |

Accouplement pour mini-pelles et mini-excavateurs

Eganche adaptación minicargadora |

Attachment miniloader |

Accouplement minichargeuses

TFVLIHML • KRISHNA



TRITURADORA LIGERA DE MARTILLOS O CUCHILLAS CON MOTOR HIDRÁULICO DE ENGRANAJES, TRANSMISIÓN POR CORREAS AL EJE PARA MINIEXCAVADORA DE 2 A 5 TON. PARA TRONCOS DE Ø5

Trituradoras de martillos o cuchillas con motor hidráulico de engranajes y transmisión por correas al eje. Para miniexcavadoras de 2 a 5 Tn. Para ramas de hasta 5 cm de diámetro. Enganche para adaptación a miniexcavadoras. El bastidor de la máquina es de chapa de alto límite elástico HARDOX.

LIGHT-WEIGHT MULCHER WITH SWINGING HAMMERS OR FLAILS AND WITH AN HYDRAULIC GEAR PUMP AND BELT DRIVE FIT MINI-EXCAVATOR FROM 2 TO 5 TON. FOR LOGS FROM Ø5

Mulcher with hammers or flails. Equipped with an hydraulic pump and belt drive. Suitable for excavators from 2-5 Tn. For branches up to 5cm diameter. For branches from 5cm diameter. Attachment for mini excavators. The machine frame is made of HARDOX high strength sheet metal.













BROYEUR LEGÈRE À MARTEAUX OSCILLANTS OU LAMES ET MOTEUR HYDRAULIQUE À ENGRANAGES AVEC COURROIES POUR L'ACCOUPLÉMENT SUR MINI-PELLES DU 2 A 5 TON. POUR TRONCS DU Ø5

Broyeur avec marteaux ou lames. Entraîné par moteur hydraulique et courroies pour mini-pelles du 2 à 5 Tn. Pour branches jusqu'à 5cm de diamètre. Pièces de fixation sur mini-pelles. Le châssis de la machine est fabriqué en tôle HARDOX à haute résistance.



Equipamiento de serie | Standard equipment | **Équipement standard**

Modelos | Model | **Modèle**

			TFVLIHML 80	TFVLIHML 120
	Peso excav. Weight excav. Poids Pelle	Tn / lb	2- 5 / 4.409 - 11.023	2- 5 / 4.409 - 11.023
	Ancho trabajo Working Width Largeur travail	cm / inch	80 / 31	120 / 47
	Medidas exteriores Outer dimensions Mesures extérieures	A cm / inch B cm / inch C cm / inch	52 / 20 108 / 43 93 / 37	52 / 20 148 / 58 93 / 37
	Ø Rotor con martillos Ø Rotor with hammers Ø Rotor avec marteaux	cm / inch	35 / 14	35 / 14
	Ø máx. tronco Ø máx. trunc Ø max. tronc	cm / inch	5 / 2	5 / 2
	Martillos Hammers Marteaux oscillants	Nº	14	18
	Peso Weight Poids	kg / lb	268 / 591	300 / 661
	Correas Belts Courroies	Nº	3B	3B
	Caudal aceite Oil flow Débit d'huile	l / gpm	40 - 60 / 10 - 16	65 - 85 / 17 - 22
	Presión Pressure Pression	BAR / PSI	180 - 200 / 2.611 - 2.901	180 - 200 / 2.611 - 2.901
	Protección trasera Rear protection Protection arrière		Cadena Chain Chaîne	
	Protección delantera Front guard Protection frontal		Goma Rubber Gomme	
	Patín protecc. chasis Skids chasis protec. Patins protec chasis		De serie Standard De série	



Equipamiento de serie | Standard equipment | Équipement standard

Latiguillos incluidos | Hoses included | **Fléxibles inclus**

Opciones | Options | Options

Eganche adaptación a miniexcavadora |

Attachment for mini-excavator |

Accouplement pour mini-pelles et mini-excavateurs

TFVLIHM • CABRIEL



TRITURADORA LIGERA DE MARTILLOS O CUCHILLAS CON MOTOR HIDRÁULICO DE ENGRANAJES. TRANSMISIÓN POR CORREAS AL EJE PARA MINIEXCAVADORA DE 4 A 8 TON. PARA TRONCOS DE Ø6CM

TFVLIHM Trituradoras de martillos o cuchillas con motor hidráulico y transmisión por correas al eje Para miniexcavadoras de 4 a 8 Tn. Para ramas de hasta 6 cm de diámetro. Eganche para adaptación a miniexcavadoras. El bastidor de la máquina es de chapa de alto límite elástico HARDOX.

LIGHT-WEIGHT MULCHER WITH SWINGING HAMMERS OR FLAILS AND WITH AN HYDRAULIC GEAR PUMP AND BELT DRIVE FIT MINI-EXCAVATOR FROM 4 TO 8 TON. FOR LOGS FROM Ø6CM

T.F.V.L.I.H.M. mulcher with hammers or flails. Equipped with an hydraulic pump and belt drive. Suitable for excavators from 4-8 Tn. For branches up to 6 cm diameter. For branches from 5-6 cm diameter. Attachment for mini excavators. The machine frame is made of HARDOX high strength sheet metal.















BROYEUR LEGÈRE À MARTEAUX OSCILLANTS OU LAMES ET MOTEUR HYDRAULIQUE À ENGRANAGES AVEC COURROIES POUR L'ACCOUPLÉMENT SUR MINI-PELLES DU 4 A 8 TON. POUR TRONCS DU Ø6CM

Broyeur TFVLIHM avec marteaux ou lames. Entraîné par moteur hydraulique et courroies pour mini-pelles du 4 à 8 Tn. Pour branches jusqu'à 6 cm de diamètre. Pièces de fixation sur mini-pelles. Le châssis de la machine est fabriqué en tôle HARDOX à haute résistance.



Equipamiento de serie |
Standard equipment |
Équipement standard

Modelos | Model | **Modèle**

			TFVLIHM 80	TFVLIHM 100	TFVLIHM 120	TFVLIHM 140	TFVLIHM 160
	Peso excav. Weight ex- cav. Poids Pelle	Tn / lb	4 - 8 / 8.818 - 17.637	4 - 8 / 8.818 - 17.637	4 - 8 / 8.818 - 17.637	4 - 8 / 8.818 - 17.637	4 - 8 / 8.818 - 17.637
	Ancho trabajo Working Width Largeur travail	cm / inch	80 / 31	100 / 39	120 / 47	140 / 55	160 / 63
	Medidas exteriores Outer dimensions Mesures extérieures	A cm / inch B cm / inch C cm / inch	52 / 20 108 / 43 93 / 37	52 / 20 128 / 50 93 / 37	52 / 20 148 / 58 93 / 37	52 / 20 168 / 66 93 / 37	52 / 20 188 / 74 93 / 37
	Ø Rotor con martillos Ø Rotor with hammers Ø Rotor avec marteaux	cm / inch	37 / 14,5	37 / 14,5	37 / 14,5	37 / 14,5	37 / 14,5
	Ø máx. tronco Ø máx. trunc Ø max. tronc	cm / inch	6 / 2,4	6 / 2,4	6 / 2,4	6 / 2,4	6 / 2,4
	Martillos Hammers Marteaux oscillants	Nº	14	16	18	22	26
	Cuchilla Blades Lames	Nº	48	56	72	88	96
	Peso Weight Poids	kg / lb	290 / 640	370 / 815	450 / 992	530 / 1170	610 / 1344
	Correas Belts Courroies	Nº	3B	3B	3B	3B	3B
	Caudal aceite Oil flow Débit d'huile	l / gpm	55 - 65 / 15 - 17	55 - 65 / 15 - 17	70 - 80 / 18 - 21	70 - 80 / 18 - 21	70 - 80 / 18 - 21
	Presión Pressure Pres- sion	BAR / PSI	200 / 2.901	200 / 2.901	200 / 2.901	200 / 2.901	200 / 2.901
	Protección trasera Rear protection Protection arrière		Cadena Chain Chaîne				
	Protección delantera Front guard Protection frontal		Goma Rubber Gomme				
	Rodillo regulable altura Roller height adjust Rouleau réglable en hau- teur		De serie Standard De serié				
	Patín protecc. chasis Skids chasis protec. Patins protec chasis		De serie Standard De serié				



Equipamiento de serie | Standard equipment | Équipement standard

Latiguillos incluidos | Hoses included | **Fléxibles inclus**

Opciones | Options | Options

Enganche adaptación a miniexcavadora |
Attachment for mini-excavator |

Accouplement pour mini-pelles et mini-excavateurs



TFVLMFH • TOCATINS



TFVLMFH - TRITURADORAS HIDRÁULICAS LIGERAS PARA EXCAVADORA DE 5 A 10 TN.

TFVLMFH Trituradoras de martillos fijos de widia con motor hidráulico de engranajes y transmisión por correas al eje. Para miniexcavadoras de 5 a 10 Tn. Para ramas de hasta 12 cm de diámetro. Enganche para adaptación a miniexcavadoras y minicargadoras. El bastidor de la máquina es de chapa de alto límite elástico HARDOX.

TFVLMFH - LIGHTWEIGHT HYDRAULIC MULCHERS TO FIT MINI EXCAVATORS FROM 5 TO 10 TN

TFVLMFH mulcher with fixed widia hammers equipped with an hydraulic gear pump and belt drive. Suitable for excavators from 5-12 tn. For branches up to 10 cm diameter. Attachment for mini excavators and mini loader. The machine frame is made of HARDOX high strength sheet metal.















TFVLMFH - BROYEURS HYDRAULIQUES LÉGERS POUR MINIPELLES DU 5 À 10 TN.

Broyeur TFVLMFH avec marteaux fixes en widia. Entraîné par moteur hydraulique à engranages et courroies pour mini-pelles du 5 à 12 Tn. Pour branches jusqu'à 10 cm de diamètre. Pièces de fixation sur mini-pelles et mini-chargeuse. Le châssis de la machine est fabriqué en tôle HARDOX à haute résistance.



Equipamiento de serie | Standard equipment
| **Équipement standard**

Modelos | Model | **Modèle**

			TFVLMFH 80	TFVLMFH 100	TFVLMFH 120	TFVLMFH 140	TFVLMFH 160
	Peso excav. Weight excav. Poids Pelle	Tn / lb	5 - 10 / 11.023 - 22.046	5 - 10 / 11.023 - 22.046	5 - 10 / 11.023 - 22.046	5 - 10 / 11.023 - 22.046	5 - 10 / 11.023 - 22.046
	Ancho trabajo Working Width Largeur travail	cm / inch	80 / 31	100 / 39	120 / 47	140 / 55	160 / 63
	Medidas exteriores Outer dimensions Mesures extérieures	A cm / inch B cm / inch C cm / inch	52 / 20 108 / 43 93 / 37	52 / 20 128 / 50 93 / 37	52 / 20 148 / 58 93 / 37	52 / 20 168 / 66 93 / 37	52 / 20 188 / 74 93 / 37
	Ø Rotor con martillos Ø Rotor with hammers Ø Rotor avec marteaux	cm / inch	39 / 15,5	39 / 15,5	39 / 15,5	39 / 15,5	39 / 15,5
	Ø máx. tronco Ø máx. trunc Ø max. tronc	cm / inch	12 / 4,7	12 / 4,7	12 / 4,7	12 / 4,7	12 / 4,7
	Martillos fijos Vidia Fixed Vidia Hammers Marteaux fixes Vidia	Nº	18	20	24	28	30
	Peso Weight Poids	kg / lb	320 / 705	400 / 881	480 / 1058	560 / 1234	640 / 1410
	Correas Belts Courroies	Nº	4B	4B	4B	4B	4B
	Caudal aceite Oil flow Débit d'huile	l / gpm	55 - 65 / 15 - 17	55 - 65 / 15 - 17	70 - 80 / 18 - 21	70 - 80 / 18 - 21	70 - 80 / 18 - 21
	Presión Pressure Pression	BAR / PSI	200 / 2.901	200 / 2.901	200 / 2.901	200 / 2.901	200 / 2.901
	Protección delantera Front guard Protection frontal		Cadena Chain Chaîne				
	Protección trasera Back guard Protection arrière		Cadena Chain Chaîne				
	Rodillo regulable altura Roller height adjust Rouleau réglable en hauteur		De serie Standard De série				
	Patín protec. chasis Skids chasis protec. Patins protec chasis		De serie Standard De série				

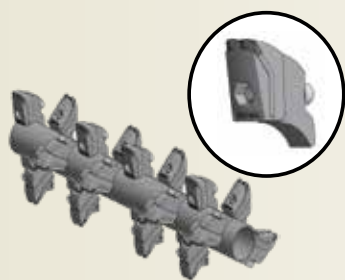

Equipamiento de serie | Standard equipment | **Équipement standard**

Válvula anticavitación y latiguillos incluidos en el precio

Anti-cavitation valve and hoses included in the price

Anti-cavitation vannes et tuyaux inclus dans le prix

Latiguillos incluidos | Hoses included | **Fléxibles inclus**

Opciones | Options | **Options**

Enganche adaptación a miniexcavadora | Attachment for mini-excavator

Accouplement pour mini-pelles et mini-excavateurs



TFVNMFH • MEKONG



TRITURADORA HIDRÁULICA FORESTAL CON MARTILLO FIJO PARA MINIEXCAVADORAS DE 5 A 12 TN.

Equipado con motor hidráulico de pistones y transmisión por correa y puerta hidráulica. Para ramas de hasta 12 cm de diámetro. Trituradora para miniexcavadoras. Posible acoplamiento también para minicargadoras. El bastidor de la máquina es de chapa de alto límite elástico HARDOX.

HYDRAULIC FORESTRY MULCHER WITH FIXED HAMMER TO FIT MINI EXCAVATORS FORM 5 TO 12 TN.















Equipped with an hydraulic piston pump and belt drive and hydraulic door. For branches up to 12 cm diameter. Attachment for mini excavators. Possible attachment for mini loaders. The machine frame is made of HARDOX high strength sheet metal.

BROYEUR HYDRAULIQUE FORESTIER À MARTEAU FIXE POUR MINI-PELLES DE 5 À 12 TONNES.

Équipé d'une moteur hydraulique à pistons et d'un entraînement par courroie et d'une porte hydraulique. Pour les branches jusqu'à 12 cm de diamètre. Concasseur pour mini pelles. Le châssis de la machine est fabriqué en tôle HARDOX à haute résistance.



Equipamiento de serie | Standard equipment | **Équipement standard**

			Modelos Model Modèle	
			TFVNMFH 100	TFVNMFH 120
	Peso excav. Weight excav. Poids Pelle	Tn / lb	5 - 12 / 11.023 - 26.455	5 - 12 / 11.023 - 26.455
	Ancho trabajo Working Width Largeur travail	cm / inch	100 / 39	120 / 47
	Medidas exteriores Outer dimensions Mesures extérieures	A cm / inch B cm / inch C cm / inch	52 / 20 128 / 50 93 / 37	52 / 20 148 / 58 93 / 37
	Ø Rotor con martillos Ø Rotor with hammers Ø Rotor avec marteaux	cm / inch	39 / 15,5	39 / 15,5
	Ø máx. tronco Ø máx. trunc Ø max. tronc	cm / inch	12 / 4,7	12 / 4,7
	Martillos fijos Widia Fixed Widia Hammers Marteaux fixes Widia		20	24
	Peso Weight Poids	kg / lb	440 / 970	480 / 1.058
	Correas Belts Courroies	Nº	4B	4B
	Caudal aceite Oil flow Débit d'huile	l / gpm	60 - 95 / 16 - 25	60 - 95 / 16 - 25
	Presión Pressure Pression	BAR / PSI	180 - 200 2.611 - 2.901	180 - 200 2.611 - 2.901
	Protección delantera Front guard Protection frontal		Puerta hidráulica Hydraulic door Portaile hydraulique	
	Protección trasera Back guard Protection arrière		Cadena Chain Chaîne	
	Rodillo regulable altura Roller height adjust Rouleau réglable en hauteur		De serie Standard De serié	
	Patín protecc. chasis Skids chasis protec. Patins protec chasis		De serie Standard De serié	



Equipamiento de serie | Standard equipment | Équipement standard

Válvula anticavitación y latiguillos incluidos en el precio
Anti-cavitation valve and hoses included in the price
Anti-cavitation vannes et tuyaux inclus dans le prix

Opciones | Options | Options

Enganche adaptación a miniexcavadora | Attachment for mini-excavator
Accouplement pour mini-pelles et mini-excavateurs

Motor de pistones cilindrado variable automatico | Automatic variable displacement piston engine | **Moteur à pistons à cylindrée variable autom. (20-30cc)**

Electro válvula doble bobina accionamiento puerta hidráulica | Electro valve double coil hydraulic door drive | **Entraînement de porte hydraulique à double bobine d'électrovanne**

TFVJAH • LACHLAN



TRITURADORA FORESTAL DE MARTILLOS MÓVILES EQUIPADA CON MOTOR HIDRÁULICO DE PISTONES PREPARADA PARA ADAPTAR A EXCAVADORAS Y MINICARGADORAS DE 7 a 16 TON. PARA TRONCOS HASTA \varnothing 14cm

El bastidor de la máquina es de chapa de alto límite elástico HARDOX.













FORESTRY MULCHER WITH SWINGING HAMMERS EQUIPPED WITH HYDRAULIC PUMP OF PISTONS READY TO BE ATTACHED TO A EXCAVATOR OR MINILOADER FROM 7 to 16 TON. FOR LOGS UP TO \varnothing 14cm

The machine frame is made of HARDOX high strength sheet metal.

BROYEUR FORESTIER Marteaux OSCILLANTS EQUIPÉ AVEC UN MOTEUR HYDRAULIQUE À PISTON POUR L'ACCOUPEMENT SUR PELLETS ET MINI CHARGEUSES DU 7 a 16 TON. POUR TRONCS JUSQU'À \varnothing 14cm

Le châssis de la machine est fabriqué en tôle HARDOX à haute résistance.



Equipamiento de serie Standard equipment Équipement standard		Modelos Model Modèle					
		TFVJAH 100	TFVJAH 130	TFVJAH 150	TFVJAH 180	TFVJAH 200	TFVJAH 225
	Tn / lb	7 - 16 / 15.432 - 35.274	7 - 16 / 15.432 - 35.274	7 - 16 / 15.432 - 35.274	7 - 16 / 15.432 - 35.274	7 - 16 / 15.432 - 35.274	7 - 16 / 15.432 - 35.274
	cm / inch	100 / 39	130 / 51	150 / 59	180 / 71	200 / 79	225 / 89
	A cm / inch	88 / 35	88 / 35	88 / 35	88 / 35	88 / 35	88 / 35
	B cm / inch	128 / 50	158 / 62	178 / 70	208 / 82	228 / 90	248 / 98
	C cm / inch	101 / 40	101 / 40	101 / 40	101 / 40	101 / 40	101 / 40
	cm / inch	43,5 / 17	43,5 / 17	43,5 / 17	43,5 / 17	43,5 / 17	43,5 / 17
	cm / inch	9 / 3,5	9 / 3,5	9 / 3,5	9 / 3,5	9 / 3,5	9 / 3,5
		14	16	18	20	22	24
	kg / lb	750 / 1653	804 / 1773	858 / 1892	914 / 2015	968 / 2134	1024 / 2258
	Nº	5	5	5	5	5	5
	l / gpm	80 - 120 / 21 - 32	80 - 120 / 21 - 32	80 - 120 / 21 - 32	80 - 120 / 21 - 32	80 - 120 / 21 - 32	80 - 120 / 21 - 32
	BAR / PSI	200 - 260 / 2.901 - 3.771	200 - 260 / 2.901 - 3.771	200 - 260 / 2.901 - 3.771	200 - 260 / 2.901 - 3.771	200 - 260 / 2.901 - 3.771	200 - 260 / 2.901 - 3.771
		Cadena doble Double chain Chaîne double					
		Opcional Option En option					
		De serie Standard De sérié					



Equipamiento de serie | Standard equipment | **Équipement standard**

Chapa antidesgaste rotor | Rotor with wear resistant steel | **Rotor en acier anti-usure**

Motor hidráulico de pistones | Hydraulic piston engine | **Moteur hydraulique à pistons**

Opciones | Options | **Options**

Enganche para excavadora | Connection for excavators |

Accouplement pour excavateurs/pelles

Puerta trasera hidráulica | Hydraulic rear door | **Capot arrière à ouverture hydraulique**

Motor de pistones cilindrado variable automatico | Automatic variable displacement piston engine | **Moteur à pistons à cylindrée variable autom. (45-74cc)**

Electro válvula doble bobina accionamiento puerta hidráulica | Electro valve double coil hydraulic door drive | **Entraînement de porte hydraulique à double bobine d'électrovanne**

Latiguillos no incluidos | Hoses not included | **Fléxibles non inclus**



TFVJH • NAVIA



TRITURADORA FORESTAL DE MARTILLOS MÓVILES 360° EQUIPADA CON MOTOR HIDRÁULICO DE PISTONES PREPARADA PARA ADAPTAR A EXCAVADORAS Y MINICARGADORAS DE 10 A 20 TON. PARA TRONCOS DE HASTA Ø20CM

El bastidor de la máquina es de chapa de alto límite elástico HARDOX.

FORESTRY MULCHER WITH 360° SWINGING HAMMERS EQUIPPED WITH HYDRAULIC OF PISTONS PUMP READY TO BE ATTACHED TO A EXCAVATOR OR MINILOADER FROM 10 TO 20 TON. FOR LOGS UP TO Ø20CM

The machine frame is made of HARDOX high strength sheet metal.

BROYEUR FORESTIER À MARTEAUX OSCILLANTS 360° EQUIPÉ AVEC UN MOTEUR HIDRAULIQUE DE PISTONS POUR L'ACCOUPLÉMENT SUR PELLES ET MINI-CHARGEUSES DU 10 A 20 TON. POUR TRONCS JUSQU'À Ø20CM

Le châssis de la machine est fabriqué en tôle HARDOX à haute résistance.



Equipamiento de serie | Standard equipment | **Équipement standard**

Modelos | Model | **Modèle**

		TFVJH 100	TFVJH 130	TFVJH 150	TFVJH 180	TFVJH 200	TFVJH 225
	Tn / lb	10 - 20 / 22.046 - 44.092	10 - 20 / 22.046 - 44.092	10 - 20 / 22.046 - 44.092	10 - 20 / 22.046 - 44.092	10 - 20 / 22.046 - 44.092	10 - 20 / 22.046 - 44.092
	cm / inch	100 / 39	130 / 51	150 / 59	180 / 71	200 / 79	225 / 89
	A cm / inch B cm / inch C cm / inch	88 / 35 128 / 50 101 / 40	88 / 35 158 / 62 101 / 40	88 / 35 178 / 70 101 / 40	88 / 35 208 / 82 101 / 40	88 / 35 228 / 90 101 / 40	88 / 35 248 / 98 101 / 40
	cm / inch	46 / 18	46 / 18	46 / 18	46 / 18	46 / 18	46 / 18
	cm / inch	20 / 8	20 / 8	20 / 8	20 / 8	20 / 8	20 / 8
	Nº	16	20	24	28	32	36
	kg / lb	892 / 1.967	994 / 2.191	1.094 / 2.412	1.196 / 2.637	1.298 / 2.862	1.400 / 3.086
	Nº	5	5	5	7	7	7
	l / gpm	80 - 120 / 21 - 32	80 - 120 / 21 - 32	80 - 120 / 21 - 32	80 - 120 / 21 - 32	80 - 120 / 21 - 32	80 - 120 / 21 - 32
	BAR / PSI	200 - 260 / 2.901 - 3.771	200 - 260 / 2.901 - 3.771	200 - 260 / 2.901 - 3.771	200 - 260 / 2.901 - 3.771	200 - 260 / 2.901 - 3.771	200 - 260 / 2.901 - 3.771
		Cadena doble Double chain Chaîne double					
		De serie Standard De série					

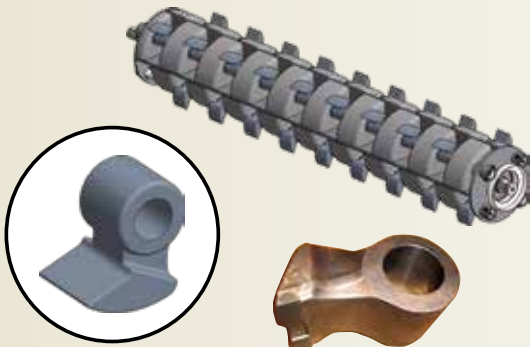

Equipamiento de serie | Standard equipment | **Équipement standard**

Martillos de widia
Widia hammers

Chapa antidesgaste rotor | Rotor with wear resistant steel | **Rotor en acier anti-usure**

Marteaux en widia

Motor hidráulico de pistones | Hydraulic piston engine | **Moteur hydraulique à pistons**

Opciones | Options | **Options**

Enganche para excavadora | Connection for excavators |

Accouplement pour excavateurs/pelles

Puerta trasera hidráulica | Hydraulic rear door | **Capot arrière à ouverture hydraulique**

Motor de pistones cilindrado variable automatico | Automatic variable displacement piston engine |

Moteur à pistons à cylindrée variable autom. (45-74cc)

Electro válvula doble bobina accionamiento puerta hidráulica | Electro valve double coil hydraulic door drive | **Entraînement de porte hydraulique à double bobine d'électrovanne**

TFVJMFH • COLUMBIA



TRITURADORA FORESTAL DE MARTILLOS FIJOS CON PUNTA DE WIDIA EQUIPADA CON MOTOR HIDRÁULICO DE PISTONES PREPARADA PARA ADAPTAR A EXCAVADORAS Y MINICARGADORAS DE 12 A 20 TON. PARA TRONCOS DE HASTA Ø20 CM

El bastidor de la máquina es de chapa de alto límite elástico HARDOX.

FORESTRY MULCHER WITH FIXED WIDIA HAMMERS EQUIPPED WITH HYDRAULIC OF PISTONS PUMP READY TO BE ATTACHED TO A EXCAVATOR OR MINILOADER FROM 12 TO 20 TON. FOR LOGS UP TO Ø20CM

The machine frame is made of HARDOX high strength sheet metal.













BROYEUR FORESTIER À MARTEAUX FIXES EN WIDIA EQUIPÉ AVEC UN MOTEUR HYDRAULIQUE DE PISTONS POUR L'ACCOUPEMENT SUR PELLER ET MINI CHARGEUSES DU 12 A 20 TON. POUR TRONCS JUSQU'À Ø20CM

Le châssis de la machine est fabriqué en tôle HARDOX à haute résistance.



Equipamiento de serie | Standard equipment | **Équipement standard**

Modelos | Model | **Modèle**

		TFVJMFH 100	TFVJMFH 130	TFVJMFH 150	TFVJMFH 180	TFVJMFH 200	TFVJMFH 225
	Tn / lb	12- 20 / 26.455 - 44.092	12- 20 / 26.455 - 44.092	12- 20 / 26.455 - 44.092	12- 20 / 26.455 - 44.092	12- 20 / 26.455 - 44.092	12- 20 / 26.455 - 44.092
	cm / inch	100 / 39	130 / 51	150 / 59	180 / 71	200 / 79	225 / 89
	A cm / inch B cm / inch C cm / inch	88 / 35 128 / 50 101 / 40	88 / 35 158 / 62 101 / 40	88 / 35 178 / 70 101 / 40	88 / 35 208 / 82 101 / 40	88 / 35 228 / 90 101 / 40	88 / 35 248 / 98 101 / 40
	cm / inch	7 / 2,7	7 / 2,7	7 / 2,7	7 / 2,7	7 / 2,7	7 / 2,7
	cm / inch	46 / 18	46 / 18	46 / 18	46 / 18	46 / 18	46 / 18
	cm / inch	20 / 8	20 / 8	20 / 8	20 / 8	20 / 8	20 / 8
	Nº (Mo- delo A)	16 + 2	20 + 2	24 + 2	28 + 2	32 + 2	34 + 2
	Nº (Mo- delo B)	20 + 2	26 + 2	34 + 2	36 + 2	42 + 2	46 + 2
	kg / lb	720 / 1.587	820 / 1.808	932 / 2.055	1.034 / 2.280	1.136 / 2.504	1.238 / 2.729
	kg / lb B	750/1.653	863 / 1.903	1.004 / 2.213	1.092 / 2.407	1.208 / 2.663	1.324/2.919
	Nº	5	5	7	7	7	7
	l / gpm	80 - 120 / 21 - 32	80 - 120 / 21 - 32	80 - 120 / 21 - 32	80 - 120 / 21 - 32	80 - 120 / 21 - 32	80 - 120 / 21 - 32
	BAR / PSI	200 - 260 / 2.901 - 3.771	200 - 260 / 2.901 - 3.771	200 - 260 / 2.901 - 3.771	200 - 260 / 2.901 - 3.771	200 - 260 / 2.901 - 3.771	200 - 260 / 2.901 - 3.771
		Cadena doble Double chain Chaîne double					
		De serie Standard De sérié					



Equipamiento de serie |
Standard equipment | **Équipement standard**

Motor hidráulico de pistones |
Hydraulic piston engine |
Moteur hydraulique à pistons



Ref. 010700050



Ref. 010700200

Opciones | Options | Options

Enganche para excavadora | Connection for excavators |
Accouplement pour excavateurs/pelles

Puerta trasera hidráulica | Hydraulic rear door | **Capot arrière à ouverture hydraulique**

Motor de pistones cilindrado variable automatico | Automatic variable displacement piston engine |
Moteur à pistons à cylindrée variable autom. (75-74cc)

Electro válvula doble bobina accionamiento puerta hidráulica | Electro valve double coil
hydraulic door drive | **Entraînement de porte hydraulique à double bobine d'électrovanne**

Latiguillos no incluidos | Hoses not included | **Flexibles non inclus**



TFVMFHE • TAMESIS



TRITURADORA HIDRÁULICA FORESTAL DE 18 a 30 TN

Diseñada para satisfacer a todos nuestros clientes. Con una construcción muy robusta con chapa de alto límite elástico. Adecuada para arbustos y troncos de hasta 300 mm de diámetro así como para todo tipo de usos de madera, jardinería y agrícola.

El bastidor de la máquina es de chapa de alto límite elástico HARDOX.

HYDRAULIC FORESTRY MULCHER FOR EXCAVATEURS FROM 18 TO 30 T

Designed to satisfy all our clients. With a very robust construction with high elastic limit sheet metal. Suitable for bushes and trunks up to 300 mm in diameter as well as for all types of wood, gardening and agricultural uses.

The machine frame is made of HARDOX high strength sheet metal.

BROYEUR HYDRAULIQUE FORESTIER DE 18 à 30 TN











Conçu pour satisfaire tous nos clients. Avec une construction très robuste avec une tôle à haute limite élastique. Convient aux buissons et troncs jusqu'à 300 mm de diamètre ainsi qu'à tous les types de bois, de jardinage et d'utilisation agricole.

Le châssis de la machine est fabriqué en tôle HARDOX à haute résistance.



Equipamiento de serie | Standard equipment |
Équipement standard

Modelos | Model | **Modèle**

			TFVMFHE 130	TFVMFHE 150	TFVMFH 180
	Peso excav. Weight excav. Poids Pelle	Tn / lb	18 - 30 / 39.683 - 66.139	18 - 30 / 39.683 - 66.139	18 - 30 / 39.683 - 66.139
	Ancho trabajo Working Width Largeur travail	cm / inch	130 / 51	150 / 59	180 / 71
	Medidas exteriores Outer dimensions Mesures extérieures	A cm / inch B cm / inch C cm / inch	130 / 51 164 / 64,5 100 / 40	130 / 51 184 / 72,5 100 / 40	130 / 51 214 / 84,5 100 / 40
	Ø Rotor con martillos Ø Rotor with hammers Ø Rotor avec marteaux	cm / inch	47 / 18,5	47 / 18,5	47 / 18,5
	Ø máx. tronco Ø máx. trunc Ø max. tronc	cm / inch	30 / 12	30 / 12	30 / 12
	Martillos fijos Vidia Fixed Vidia Hammers Marteaux fixes Vidia ROTOR A	Nº	20 + 2	24 + 2	28 + 2
	Martillos fijos Vidia Fixed Vidia Hammers Marteaux fixes Vidia ROTOR B	Nº	26 + 2	34 + 2	36 + 2
	Peso Weight Poids	kg / lb	1.280 / 2.822	1.330 / 2.932	1.380 / 3.042
	Peso mod. B Weight B Poids B	kg / lb	1.325 / 2.921	1.402 / 3.091	1.438 / 3.170
	Correas Belts Courroies	Nº	6	6	6
	Caudal aceite Oil flow Débit d'huile	l / gpm	150 - 250 / 40 - 66	150 - 250 / 40 - 66	150 - 250 / 40 - 66
	Presión Pressure Pression	BAR / PSI	200 - 260 / 2.901 - 3.771	200 - 260 / 2.901 - 3.771	200 - 260 / 2.901 - 3.771
	Protección delantera Front guard Protection frontal		Cadena doble Double chain Chaîne double		
	Patín protecc. chasis Skid chasis protec. Patins protec chasis		De serie Standard De série		

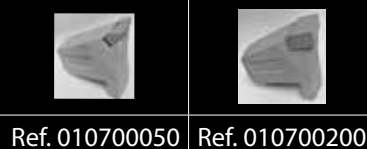

Rotor B

Equipamiento de serie | Standard equipment | Équipement standard

Motor hidráulico de pistones | Hydraulic piston engine | **Moteur hydraulique à pistons**

Puerta trasera hidráulica | Hydraulic rear door | **Capot arrière à ouverture hydraulique**

Opciones | Options | Options

Enganche para excavadora | Connection for excavators |

Accouplement pour excavateurs/pelles

Motor de pistones cilindrado variable automatico | Automatic variable displacement piston engine | **Moteur à pistons à cylindrée variable autom. (56-80cc)**

Electro válvula doble bobina accionamiento puerta hidráulica | Electro valve double coil hydraulic door drive | **Entraînement de porte hydraulique à double bobine d'électrovanne**

Latiguillos no incluidos | Hoses not included | **Fléxibles non inclus**

TFVH • DON



TRITURADORA FORESTAL DE MARTILLOS MÓVILES 360° EQUIPADA CON MOTOR HIDRÁULICO DE PISTONES PREPARADA PARA ADAPTAR EXCAVADORAS DE DE 20 A 35 TON. PARA TRONCOS DE HASTA Ø35CM

El bastidor de la máquina es de chapa de alto límite elástico HARDOX.

FORESTRY MULCHER WITH 360° SWINGING HAMMERS EQUIPPED WITH HYDRAULIC ENGINE OF PISTONS READY TO BE ATTACHED TO AN EXCAVATOR FROM 20 TO 35 TON. FOR LOGS UP TO Ø35CM

The machine frame is made of HARDOX high strength sheet metal.





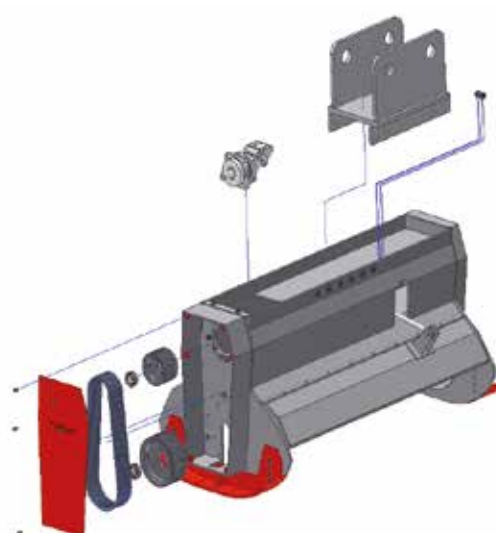







BROYEUR FORESTIER À MARTEAUX OSCILLANTS 360° ÉQUIPÉ AVEC UN MOTEUR À PISTON HYDRAULIQUE POUR L'ACCOUPLÉMENT SUR PELLES DU 20 A 35 TON. POUR TRONCS JUSQU'À Ø35CM

Le châssis de la machine est fabriqué en tôle HARDOX à haute résistance.



Equipamiento de serie | Standard equipment | **Équipement standard**

Modelos | Model | **Modèle**

			TFVH 120	TFVH 140	TFVH 160	TFVH 180	TFVH 200
	Peso excav. Weight excav. Poids Pelle	Tn / lb	20-35 / 44.092 - 77.162	20-35 / 44.092 - 77.162	20-35 / 44.092 - 77.162	20-35 / 44.092 - 77.162	20-35 / 44.092 - 77.162
	Ancho trabajo Working Width Largeur travail	cm / inch	120 / 47	140 / 55	160 / 63	180 / 71	200 / 79
	Medidas exteriores Outer dimensions Mesures extérieures	A cm / inch B cm / inch C cm / inch	110 / 43 153 / 60 112 / 44	110 / 43 173 / 68 112 / 44	110 / 43 193 / 76 112 / 44	110 / 43 213 / 84 112 / 44	110 / 43 233 / 92 112 / 44
	Ø Rotor con martillos Ø Rotor with hammers Ø Rotor avec marteaux	cm / inch	63,5 / 25	63,5 / 25	63,5 / 25	63,5 / 25	63,5 / 25
	Ø máx. tronco Ø máx. trunc Ø max. tronc	cm / inch	35 / 14	35 / 14	35 / 14	35 / 14	35 / 14
	Martillos móviles Swinging Hammers Marteaux oscillants		16	20	24	28	32
	Peso Weight Poids	kg / lb	1.430 / 3.153	1.520 / 3.351	1.615 / 3.560	1.710 / 3.770	1.800 / 3.968
	Correas Belts Courroies	Nº	6	6	6	6	6
	Caudal aceite Oil flow Débit d'huile	l / gpm	145 / 38	155 / 41	165 / 44	175 / 46	205 / 54
	Presión Pressure Pression	BAR / PSI	200 - 260 / 2.901 - 3.771	200 - 260 / 2.901 - 3.771	200 - 260 / 2.901 - 3.771	200 - 260 / 2.901 - 3.771	200 - 260 / 2.901 - 3.771
	Protección delantera Front guard Protection frontal		Cadena doble Double chain Chaîne double				
	Patín protecc. chasis Skids chasis protec. Patins protec chasis		De serie Standard De série				



Equipamiento de serie | Standard equipment | **Équipement standard**

Martillos de widia
Widia hammers
Marteaux en widia

Chapa antidesgaste rotor | Rotor with wear resistant steel | **Rotor en acier anti-usure**

Motor hidráulico de pistones | Hydraulic piston engine | **Moteur hydraulique à pistons**

Opciones | Options | **Options**

Eganche para excavadora | Connection for excavators

Accouplement pour excavateurs/pelles

Puerta trasera hidráulica | Hydraulic rear door |

Capot arrière à ouverture hydraulique

Motor de pistones cilindrado variable automatico | Automatic variable displacement piston engine |

Moteur à pistons à cylindrée variable autom. (75-108cc)

Electro válvula doble bobina accionamiento puerta hidráulica | Electro valve double coil

hydraulic door drive | **Entraînement de porte hydraulique à double bobine d'électrovanne**

Latiguillos no incluidos | Hoses not included | **Fléxibles non inclus**



TFVMFH • TIGRE

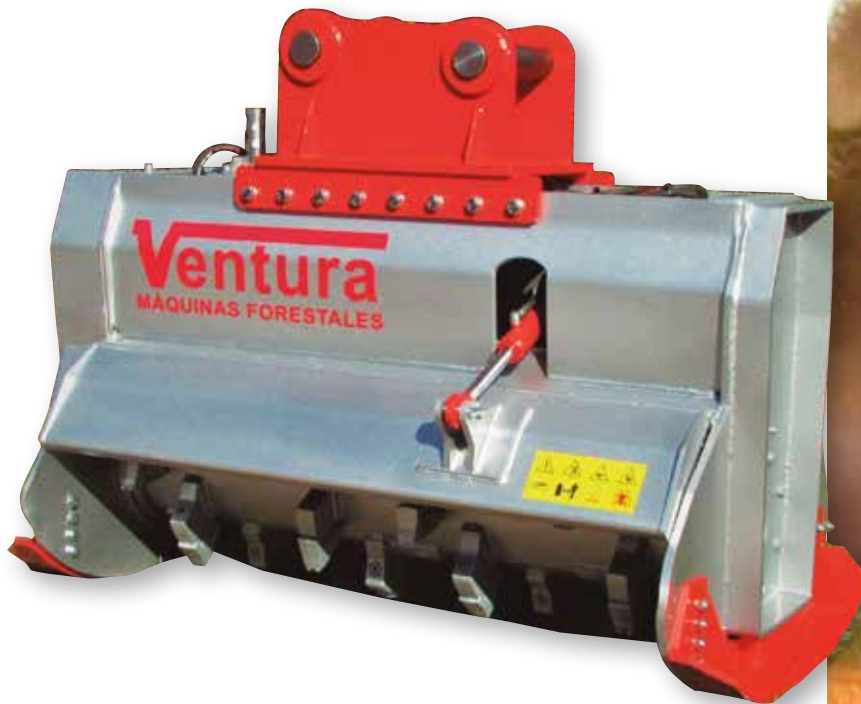

TRITURADORA FORESTAL DE MARTILLOS FIJOS CON PUNTA DE WIDIA EQUIPADA CON MOTOR HIDRÁULICO DE PISTONES PREPARADA PARA ADAPTAR EXCAVADORAS DE 20 A 35 TON. PARA TRONCOS HASTA Ø40CM

El bastidor de la máquina es de chapa de alto límite elástico HARDOX.

FORESTRY MULCHER WITH FIXED WIDIA HAMMERS EQUIPPED WITH HYDRAULIC PUMP OF PISTONS READY TO BE ATTACHED TO A EXCAVATOR FROM 20 TO 35 TON. FOR LOGS UP TO Ø40CM

The machine frame is made of HARDOX high strength sheet metal.













BROYEUR FORESTIER À MARTEAUX FIXES EN WIDIA EQUIPÉ AVEC UN MOTEUR À PISTON HYDRAULIQUE POUR L'ACCOUPLÉMENT SUR PELLES DU 20 A 35 TON. POUR TRONCS JUSQU'À Ø40CM

Le châssis de la machine est fabriqué en tôle HARDOX à haute résistance.



Equipamiento de serie | Standard equipment | **Équipement standard**

Modelos | Model | **Modèle**

			TFVMFH 120	TFVMFH 140	TFVMFH 160	TFVMFH 180	TFVMFH 200
	Peso excav. Weight excav. Poids Pelle	Tn / lb	20-35 / 44.092 - 77.162	20-35 / 44.092 - 77.162	20-35 / 44.092 - 77.162	20-35 / 44.092 - 77.162	20-35 / 44.092 - 77.162
	Ancho trabajo Working Width Largeur travail	cm / inch	120 / 47	140 / 55	160 / 63	180 / 71	200 / 79
	Medidas exteriores Outer dimensions Mesures extérieures	A cm / inch B cm / inch C cm / inch	110 / 43 153 / 60 112 / 44	110 / 43 173 / 68 112 / 44	110 / 43 193 / 76 112 / 44	110 / 43 213 / 84 112 / 44	110 / 43 233 / 92 112 / 44
	Profundidad Depth Profondeur	cm / inch	9 / 3,5	9 / 3,5	9 / 3,5	9 / 3,5	9 / 3,5
	Ø Rotor con martillos Ø Rotor with hammers Ø Rotor avec marteaux	cm / inch	58,5 / 23	58,5 / 23	58,5 / 23	58,5 / 23	58,5 / 23
	Ø máx. tronco Ø máx. trunc Ø max. tronc	cm / inch	40 / 16	40 / 16	40 / 16	40 / 16	40 / 16
	Martillos fijos Vidia Fixed Vidia Hammers Marteaux fixes Vidia	Nº (Rotor Mod. A) Nº (Rotor Mod. B)	16 + 2 32 + 2	20 + 2 40 + 2	24 + 2 48 + 2	28 + 2 56 + 2	32 + 2 64 + 2
	Peso Weight Poids	kg / lb	1.572 / 3.466	1.602 / 3.532	1.705 / 3.759	1.805 / 3.979	1.900 / 4.189
	Peso B Weight B Poids B	kg / lb	1.690 / 3.726	1.745 / 3.847	1.877 / 4.138	2.005 / 4.420	2.130 / 4.696
	Correas Belts Courroies	Nº	6	6	6	6	6
	Caudal aceite Oil flow Débit d'huile	l / gpm	155 / 41	155 / 41	165 / 44	175 / 46	205 / 54
	Presión Pressure Pression	BAR / PSI	200 - 260 / 2.901 - 3.771	200 - 260 / 2.901 - 3.771	200 - 260 / 29.01 - 3.771	200 - 260 / 2.901 - 3.771	200 - 260 / 2.901 - 3.771
	Protección delantera Front guard Protection frontal		Cadena doble Double chain Chaîne double				
	Patín protecc. chasis chasis protec. Patins protec chasis		De serie Standard De série				



Equipamiento de serie
| Standard equipment |
Équipement standard

Motor hidráulico de pistones |
Hydraulic piston engine |
Moteur hydraulique à pistons

Opciones | Options | **Options**

Enganche para excavadora | Connection for excavators
Accouplement pour excavateurs/pelles

Puerta trasera hidráulica | Hydraulic rear door | **Capot arrière à ouverture hydraulique**

Motor de pistones cilindrado variable automatico | Automatic variable displacement piston engine | **Moteur à pistons à cylindrée variable autom. (75-108cc)**

Electro válvula doble bobina accionamiento puerta hidráulica | Electro valve double coil hydraulic door drive | **Entraînement de porte hydraulique à double bobine d'électrovanne**

Latiguillos no incluidos | Hoses not included | **Fléxibles non inclus**

