

# MASCHIO



# MULCHERS RANGE

## **RESIDUE MANAGEMENT KEY TO TOP RESULTS**

Residue mulching is a very important and somewhat tricky phase as it enhances subsequent decomposition processes, helping residues break down into organic matter.

The MULCHERS range, catering to the small- and large-scale needs of farms and farmers, is a winning solution for dealing with grass, brush, crop residue and prunings. Every MASCHIO GASPARDO machine - from the lightest, compact models to the heavy-duty high-performance workhorses - is the product of the experience we have gained over the years.

Reliability and high quality are the result of continuous innovation and ongoing research.



**GIRAFFA XXL**



## **AGRONOMIC ADVANTAGES**

- Mulches crop residue to a fine consistency
- Shreds prunings and breaks their fibres
- Residues easier to work into soil
- Improved microbial breakdown
- Produces organic material
- Improves soil fertility
- Weed control
- Insect and fungal disease control

# CONTENTS

Precision and quality	4
MASCHIO mulchers, a name you can rely on	6
Light-duty mulchers	8
Mulchers	10
Multipurpose mulchers	12
Side-mounted mulchers	14
Reversible mulchers	16
Tall-chamber straw choppers	18
HEAVY-DUTY straw choppers	20
Choose the right tool	20



**BUFALO**

## **ENVIRONMENTAL ADVANTAGES**

- Reduced herbicide use
- Wide application in conservation and organic agriculture

## **FINANCIAL ADVANTAGES**

- Versatility of use
- Good work rates

# Precision and quality at every stage of the production process

## TECHNOLOGY AND INNOVATION

All MASCHIO GASPARDO mulchers are designed, developed and manufactured utilizing the best technologies to deliver maximum power and excellent performance in the field.

Our plants employ the most innovative, most advanced laser cutting and robotic welding technologies. Strict quality controls and the use of raw materials and parts sourced from top suppliers ensure that all machines meet the highest production standards. Continuous improvements and research into new models mean you can count on these machines to handle any kind of job.



## QUALITY

- Electronic balancing of each individual rotor
- Every single mulcher inspected and tested
- Superior resistance to wear



## INNOVATION

- Continuous pursuit of new hi-tech solutions
- Use of the best technologies
- High production standards



## RELIABILITY

- Extreme build quality
- Low maintenance
- Prompt and efficient customer support

# Performance and balance

## **PRIORITY NUMBER ONE, BALANCING**

To reduce both vibrations and power draw, and hence extend the machine's service life, each individual rotor is balanced electronically in a purpose-built system using technologies that are constantly being updated.



A correctly balanced rotor delivers the best possible performance and ensures lengthy implement service life.



# MASCHIO mulchers, a name you can rely on

## A RANGE CATERING TO EVERY DEMAND

MASCHIO fixed frame, offset or side-mounted mulchers make up an extensive range: from 0.95 to 6.20 m for tractors ranging from 20 up to 300 hp. Ranging from the compact to the impressive, the MASCHIO range of mulchers features professional, multipurpose implements for grass and vegetation maintenance and dealing with crop residues and prunings. Blades or hammers, together with numerous optional extras, allow the equipment to be tailored to suit each customer's various requirements. Reliable and practical, these are must-have tools in the arsenal of farmers and contractors alike.



### ROTOR MOUNTS

The extra strong rotor mounts are made from hot-formed steel and are mounted inside the end plate to protect the bearings. This makes the mulcher much stronger than competitors' versions featuring externally mounted covers.



### BARREL ROLLER BEARINGS

The HEAVY-DUTY bearings ensure unparalleled reliability and peace of mind. The special "barrel" race is designed to withstand punishing radial loads and knocks, offering unbeatable strength to handle with even the toughest jobs.

### FORWARD POSITION

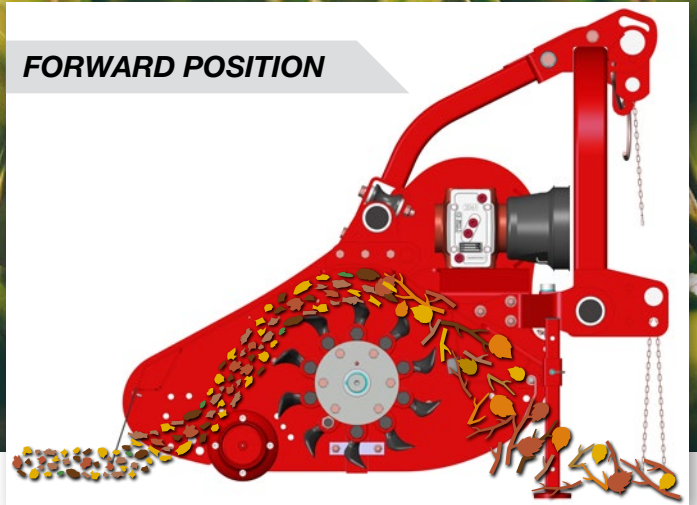

**Collecting rakes**  
for a finer mulch

**Wear-resistant sheet metal**

**Upper and lower  
toothed counter blade**

**Adjustable skids**

**Mechanical or hydraulic  
offset**

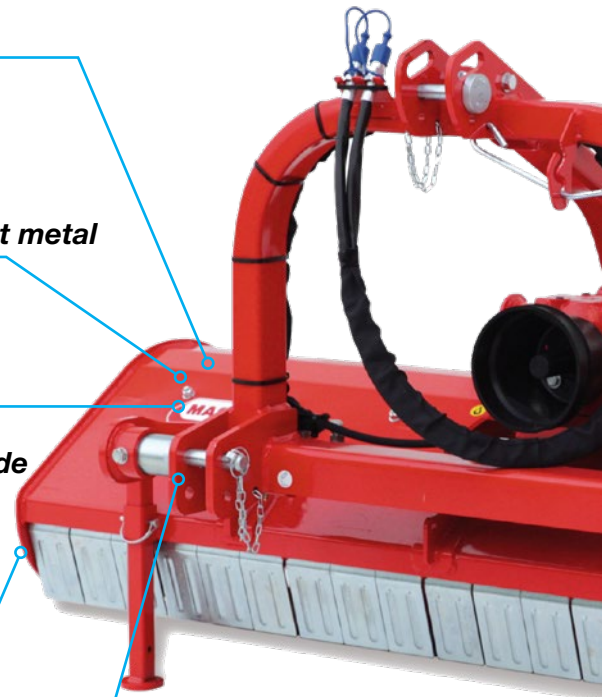

# Make short work of long grass!

## MULCHING CHAMBER

Designed and engineered to deliver unbeatable efficiency for a fine mulch even when working at higher speeds. The welded counter blade, found on all models, ensures material is cut cleanly. The rear roller can be adjusted to two configurations (forward and back). The former ensures a constant cutting height and self-cleaning effect, while the latter position - used with collecting rakes - allows the residue to be mulched into finer pieces before conveying it under the roller.

### BACK POSITION

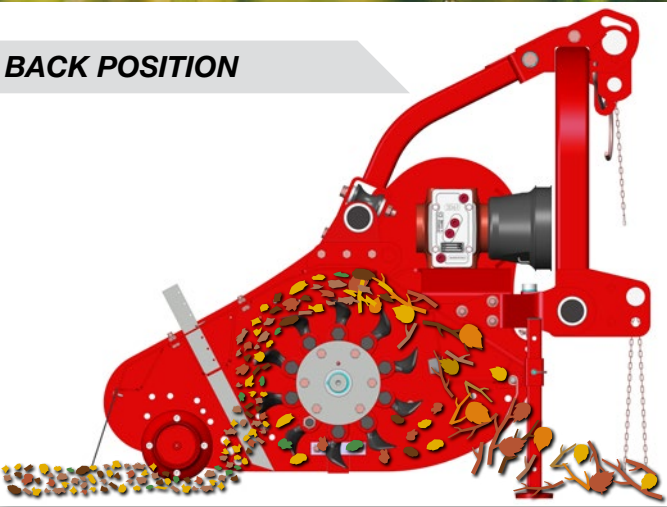

**Hammer or blade rotor**  
with tools (BARREL roller bearings)

**Belt tensioning**  
with screw system

**Belt drive**  
with free wheel safety system

**Rear roller adjustable** to 2 positions with removable covers

**Welded double-skin frame**  
(GIRAFFA XXL, TIGRE and BUFALO)



## BELT TENSIONING

Drive belts can be tensioned simply and easily by means of a practical external screw system. All implements are fitted with toothed belts that, unlike plain belts, prove more effective and offer greater performance.



## HAMMER OR BLADE ROTOR

The rotors are designed to improve mulching efficiency and minimize vibrations and power draw. The design of the tools in 8 rows in a helical arrangement creates a more consistent power draw. The anti-collision rotor prevents damage of any kind in the event the tools are hit by stones or debris.

# Light-duty mulchers

10 to 40 hp - woody material up to Ø 2 cm



**FURBA**

## **SMALL BUT TIRELESS**

This range comprises 3 simple, versatile models - JOLLY, BIRBA and FURBA - which can be paired with low-hp tractors.

The JOLLY finishing mower is designed to offer an excellent quality cut and an exceptional groomed lawn look. It is perfectly suited to all needs, from parks, gardens and sports fields to large golf courses. For improved performance, it comes with the option of side or rear grass discharge.

The reversible BIRBA and FURBA models - which are light and offer unrivalled flexibility - are perfectly suited for dealing with grass, brush and prunings up to 2 cm in diameter.

The FURBA model features mechanical or hydraulic offset for working under tree limbs and branches.



## **HEIGHT-ADJUSTABLE PIVOTING WHEELS**

The JOLLY model features 4 pivoting wheels allowing it to follow contours in the ground the grass is growing on more closely, for a consistently perfect cut and excellent manoeuvrability. Quick and simple height adjustment is achieved by means of 12mm spacers in each wheel pin, for up to 6 positions.

## **FRONT/REAR GEARBOX**

All three models can be used on the front or rear of the tractor to cater to different requirements. For best results, there is a gearbox with dual front and rear mount with a PTO speed of 1,000 rpm.





# For a millimetre-perfect cut

## JOLLY



## BIRBA



## FURBA

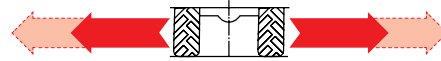

Mod.	MAX cm	MIN cm	MIN cm	MAX cm
100	60	40	40	60
120	74,5	45,5	45,5	74,5
140	84	44	56	95
160	84	44	76	116
180	84	44	91	131

SPECIFICATIONS		JOLLY SIDE	JOLLY REAR	BIRBA	FURBA
Working width	cm	120-150-180	120-150-180-210	95-115-135-155	95-115-135-155-170
Total width	cm	145-175-205	125-155-185-215	113-133-153-173	113-133-153-173-188
Weight	kg	165-190-230	165-190-230-365	180-200-220-240	195-214-236-250-258
Tractor power	hp	14-40	14-50	10-40	10-40
3-point hitch category		I	I (II for 210)	I	I
Tool type		rotary blade	rotary blade	blades-hammers	blades-hammers
Blades	n°	-	-	40-48-56-64	40-48-56-64-72
Hammers	n°	-	-	20-24-28-32	20-24-28-32-36
Transmission speed	rpm	540	540	540	540
Belts	n°	3	3	2	2
Mechanical offset		-	-	-	•
Hydraulic offset		-	-	-	◊
Reversibility		•	•	•	•
1000 rpm front/rear gearbox		◊	◊	◊	◊
Skids		-	-	•	•
Wear-resistant sheet metal		-	-	◊	-
Toothed counter blade		-	-	-	-
Collecting rakes		-	-	◊	-
Pivoting wheels		•	•	-	-

• standard ◊ optional - not available

# Mulchers

20 to 80 hp - woody material up to Ø 6 cm



## BARBI

### COMPACT AND RELIABLE

Three reliable compact models make up this range, which can be coupled with tractors ranging from 20 to 80 horsepower. BARBI, BRAVA and BRAVA L have been produced to offer unbeatable results in dealing with grass, brush and medium-sized prunings.

With their fairly compact size, BARBI and BRAVA are a real asset for customers using this equipment in grass lanes between fields, vineyards, olive groves and orchards. The BRAVA model comes in a fixed frame or side offset version. BRAVA L has been designed exclusively for the maintenance of green space areas, extending the BRAVA range somewhat with its 230 and 250 cm capacity.



### EXTERNAL BELT ADJUSTMENT: quick and simple

Power is transmitted to the rotor by three toothed belts with an adjustable pulley. There are two screws for adjusting belt tension quickly and safely.

### HYDRAULIC OFFSET: unrivalled comfort

Providing even more practical use while on the job, all models come with hydraulic offset. This allows the operator to control offset positioning without leaving the cab.



### BRAVA LARGE 230-250

BRAVA L is a light-duty, affordable model in a larger size than the BRAVA range. It comes with a fixed frame or mechanical or hydraulic offset to make any job that much easier. This model mounts the rotor from the next range up, measuring 168 mm in diameter and 10 mm thick, with blades set out in 8 rows in a helical pattern. The implement features a rear roller, which can be set just to the internal position and has 3 adjustable settings.

# Cutting and mulching quality

## BARBI

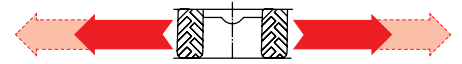

Mod.	MAX cm	MIN cm	MIN cm	MAX cm
100	60	40	40	60
120	74,5	45,5	45,5	74,5
140	84	44	56	95
160	84	44	76	116
180	84	44	91	131

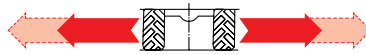

Mod.	MAX cm	MIN cm	MIN cm	MAX cm
120 F	57,5	--	--	57,5
140 F	68,5	39,5	66,5	95,5
160 F	81	40	74	115
180 F	84	42	91	133
200 F	99	59	96	136
140 S	70	41	65	94
160 S	80	40	75	115
180 S	85	45	88	128
200 S	98	58	96	136

## BRAVA

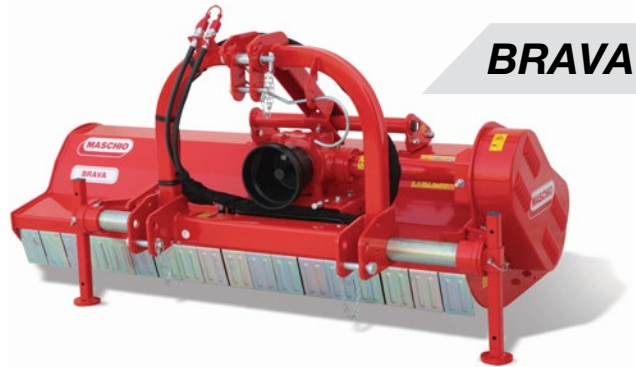

## BRAVA L

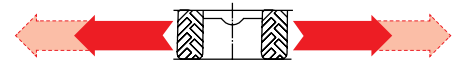

Mod.	MAX cm	MIN cm	MIN cm	MAX cm
230 L F	112	86	118	144
250 L F	126	100	131	157
230 L S	123	83	107	147
250 L S	137	97	120	160

SPECIFICATIONS		BARBI	BRAVA F	BRAVA S	BRAVA L F	BRAVA L S
Working width	cm	100-120-140-160-175	115-135-155-173-195	135-155-173-195	230-250	230-250
Total width	cm	113-133-155-175-190	133-153-173-188-208	153-173-188-208	245-270	245-270
Weight	kg	262-283-310-326-344	361-391-416-441-478	435-467-490-528	568-598	620-650
Tractor power	hp	20-45	25-80	25-80	50-80	50-80
3-point hitch category		I	I	I	I	I
Tool type		blades-hammers	blades-hammers	blades-hammers	blades-hammers	blades-hammers
Blades	n°	28-32-40-44-48	24+12-28+14-32+16-40+20-44+22	28+14-32+16-40+20-44+22	52+26-56+28	52+26-56+28
Hammers	n°	14-16-20-22-24	12-14-16-20-22	14-16-20-22	26-28	26-28
Transmission speed	rpm	540	540	540	540	540
Belts	n°	3	3	3	4	4
Mechanical offset		•	•	•	◊	◊
Hydraulic offset		◊	◊	◊	◊	◊
Reversibility		-	-	-	-	-
Front/rear gearbox 1000 rpm		-	-	-	-	-
Skids		◊	◊	◊	◊	◊
Wear-resistant sheet metal		◊	◊	◊	◊	◊
Toothed counter blade		-	◊	◊	◊	◊
Collecting rakes		-	◊	◊	◊	◊
Pivoting wheels		-	-	-	-	-

• standard ◊ optional - not available

# Multipurpose mulchers

40 to 80 hp - woody material up to Ø 12 cm



## CORAZZA

### EFFORTLESS MULCHING

Strong and reliable, the CORAZZA and TIGRE mulchers are an essential part of any farmer's or contractor's fleet of equipment. Designed and engineered to get the job done, powering through even the toughest conditions, they are suitable for dealing with green space areas, brushwood and thick prunings. CORAZZA is a fixed or side offset mulcher for mid-sized farmers who need a multipurpose implement. With its heavy-duty construction, TIGRE can cope easily with woody material up to 12 cm in diameter. Available in 5 models, from 210 up to 300 cm, it can be paired with tractors in the mid power range.

### A ROTOR THAT MAKES THE DIFFERENCE

CORAZZA has a 168mm Ø rotor measuring 10 mm thick, and comes with the option of a multi-aggressive rotor. TIGRE, designed for more heavy-duty mulching, has an extra strong 194mm Ø rotor measuring 10 mm thick, with tools in 4 rows set at 90°.

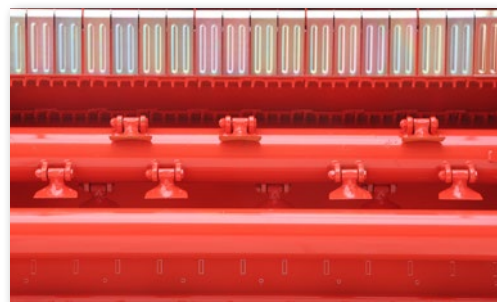

### COLLECTING RAKE KIT

For finer mulching of the residue, both models can be accessorized with adjustable collecting rakes. Residue is retained under the hood, allowing it to be broken down further to a given size.

### THE ART OF MULCHING EVEN THE THICKEST BRANCHES

The TIGRE model has been designed with a cutting chamber featuring a welded double-skinned construction (4+4 mm) and dual toothed counter blades so that more voluminous residues and thicker branches are mulched into fine pieces.



# Tireless and professional

## CORAZZA

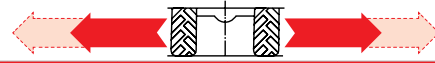

Mod.	MAX cm	MIN cm	MIN cm	MAX cm
155 F	81	40	74	115
170 F	81	40	89	130
190 F	102	50	88	140
210 F	102	54	108	156
230 F	116	68	114	162
155 S	81	46	74	109
170 S	84	49	86	121
190 S	90	55	91	135
210 S	99	55	111	155
230 S	115	71	115	159

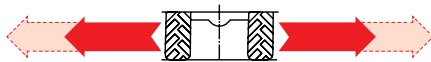

Mod.	MAX cm	MIN cm	MIN cm	MAX cm
210	119	69	91	141
230	130	80	96	146
250	144	94	113	163
280	159	109	117	167
300	159	109	139	189



SPECIFICATIONS		CORAZZA	TIGRE
Working width	cm	155-170-190-210-230	210-226-257-276-298
Total width	cm	170-185-205-225-245	233-249-280-299-321
Weight	kg	490-515-550-585-620	775-810-880-925-955
Tractor power	hp	40-80	55-140
3-point hitch category		II	II
Tool type		blades-hammers	blades-hammers
Blades	n°	48-54-60-66-72	48-60-60-72-72
Hammers	n°	16-18-20-22-24	16-20-20-24-24
Transmission speed	rpm	540	540
Belts	n°	4	5
Mechanical offset		•	•
Hydraulic offset		◊	◊
Reversibility		-	-
1000 rpm front/rear gearbox		-	-
Skids		◊	◊
Wear-resistant sheet metal		◊	-
Toothed counter blade		•	•
Collecting rakes		◊	◊
Pivoting wheels		◊	◊

• standard ◊ optional - not available

# Side-mounted mulchers

20 to 200 hp - woody material up to Ø 10 cm



**GIRAFFA XL**

## AN EXCEPTIONAL RANGE

The range of side-mounted mulchers stands out for its ease and versatility of use: dealing with grass or brush, either behind or to the side of the tractor, has never been simpler. Suitable for any use, equally happy working in olive groves, hazel groves and orchards as it is mowing along the ends of fields, ditches or hedgerows. MASCHIO GASPARDO has 4 models catering to all manner of customer requirements: GIRAFFA S, GIRAFFA M, GIRAFFA L, GIRAFFA XL and GIRAFFA XXL.



## THE STRONGEST SOLUTION

The parallelogram frame arm on the GIRAFFA L, GIRAFFA XL and GIRAFFA XXL models has been redesigned with a new forged joint to deliver greater strength and solidity. As an optional extra, GIRAFFA XL can be fitted with a multi-aggressive rotor for unrivalled mulching.

## NOWHERE THEY CAN'T REACH

All models provide good adjustment ranges for side offset and incline (- 65° to + 90°). If you require greater side work ability, the GIRAFFA M, GIRAFFA L, GIRAFFA XL and GIRAFFA XXL versions can be fitted with an externally mounted gearbox. An extremely versatile range for both farm work and road maintenance.

An efficient shock protection system protects the cutting head from possible obstacles (GIRAFFA XXL).

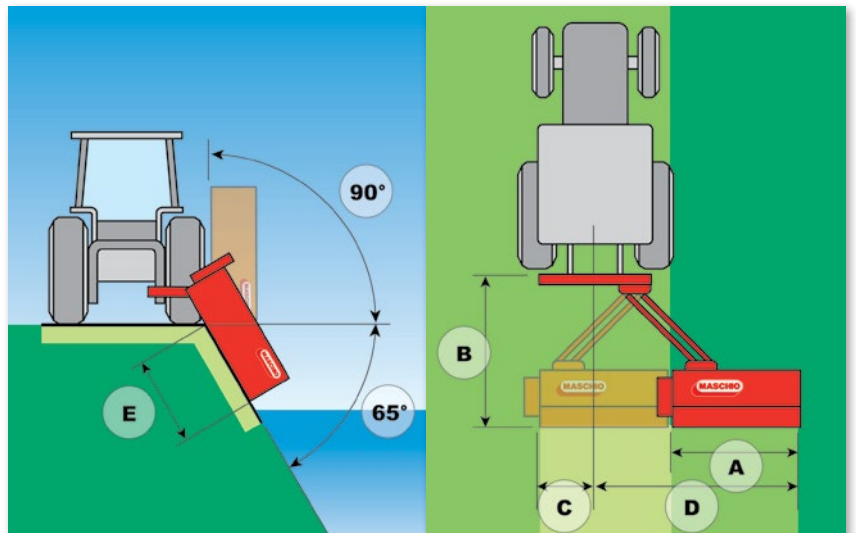

# Ready for anything

## MULTIPURPOSE AND STRONG

GIRAFFA S is the ideal mulcher for small farms, designed to meet their everyday needs. Featuring impressive versatility of use and a new strong, reinforced frame, GIRAFFA M, GIRAFFA L and GIRAFFA XL are suitable for mulching brush up to 6 cm in diameter. GIRAFFA XXL is the show stealer, suitable for more demanding workloads: the adjustable spring safety on the tractor hitch, the internal conveyor and the standard-issue double-skinned frame earn it the HEAVY DUTY label. All models feature a self-cleaning rear roller that can be adjusted to two positions.

### GIRAFFA S



### GIRAFFA M



### GIRAFFA L



### GIRAFFA XL



### GIRAFFA XXL



Modell		GIRAFFA S SI	GIRAFFA M SE	GIRAFFA L SE	GIRAFFA XL SE	GIRAFFA XXL SE
Working width	cm	115-135-155	120-140-160-175	149-164-184	157-190-212	210-226-257
Total width	cm	133-155-175	156-176-196-211	206-221-241	198-231-253	264-278-308
Weight	kg	246-266-286	385-405-425-445	620-640-660	720-780-810	1075-1110-1220
Tractor power	hp	15-35	35-60	40-80	50-110	120-200
3-point hitch cat.		I <sup>^</sup>	I <sup>^</sup>	II <sup>^</sup>	II <sup>^</sup> -III <sup>^</sup>	II <sup>^</sup> -III <sup>^</sup>
Tool type		blades-hammers	blades-hammers	blades-hammers	blades-hammers	blades-hammers
Blades	n°	48-56-64	32-40-44-48	-	48-60-66	48-60-60
Hammers	n°	24-28-32	16-20-22-24	16-20-22	16-20-22	16-20-20
Transm. speed	rpm	540	540	540	540	540
Belts	n°	3	3	4	4	5
Hydraulic offset		•	•	•	•	•
Skids		•	•	•	•	•
Wear-resistant sheet metal		-	◇	◇	◇	-
Toothed counter blade		-	•	•	•	•
A	cm	115-135-155	120-140-160-175	187-202-222	157-190-212	210-226-257
B	cm	128	145	221	170	238
C	cm	55	30	76	35	50
D	cm	172-192-212	200-220-240-255	259-274-294	265-295-320	318-334-365
E	cm	88-108-128	100-120-140-155	151-168-186	150-183-205	200-216-247

• standard ◇ optional - not available

# Reversible mulchers

30 to 200 hp – woody material up to Ø 10 cm

## BUFALO

### REVERSIBILITY FOR EVERY NEED

The range of reversible mulchers stands out for its great reliability and versatility given that the same mulcher can be used mounted on the front or rear equally efficiently. The BELLA, BISONTE and BUFALO models allow for unbeatably flexible use in any working condition paired with tractors in a wide range of horsepowers. This equipment is ideal for intensive mulching on grass, uncultivated ground, fields with a wealth of crop residue or vineyards, orchards and olive groves for pruning and grass management.

BELLA comes in working widths up to 210 cm, while BISONTE and BUFALO range up to 3 metres and can be paired with tractors in the mid to high power range.

### DOUBLE LINKAGE MOUNTING

The strength and distinctive trait of this equipment lie in the double three-point linkage mounting, with front and rear gearbox for super-fast configuration changeover (optional extra on BELLA). The gearbox with a PTO speed of 1,000 rpm means this equipment can provide consistently high performance.



### WINNING COMBINATION

Combined with rear side-mounted mulchers, these implements are great for reducing costs and speeding up work since a greater work area can be covered in a single pass.

### BISONTE and BUFALO: fearlessly tackling any terrain

These two rugged, heavy-duty models have incorporated the concepts of solid construction and safe use into their design (BUFALO features 5+5 mm double-skinned frame). Designed to be coupled with tractors up to 200 horsepower, their efficiency truly comes into its own when tackling heavy brush and thick residues, partly thanks to the dual counter blades, which make it easier to break down tough material.





# Two machines in one

## BELLA

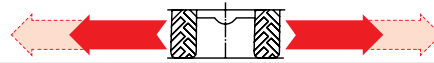

Mod.	MAX cm	MIN cm	MIN cm	MAX cm
135	82	42	53	93
155	82	42	73	113
170	96	56	74	114
190	96	56	94	134
210	96	56	114	154

## BISONTE

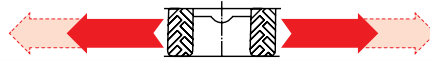

Mod.	MAX cm	MIN cm	MIN cm	MAX cm
220	113	73	113	153
250	128	88	128	168
280	138	98	138	178
300	149	109	149	189

## BUFALO

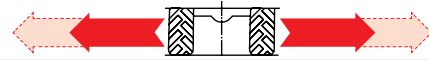

Mod.	MAX cm	MIN cm	MIN cm	MAX cm
250	129	79	121	171
280	139	89	141	191
300	154	104	156	206

SPECIFICATIONS		BELLA	BISONTE	BUFALO
Working width	cm	135-155-170-190-210	226-257-276-298	250-280-300
Total width	cm	150-170-185-205-225	249-280-299-321	270-299-330
Weight	kg	400-430-470-500-530	820-888-944-995	1190-1250-1300
Tractor power	hp	30-80	50-110	100-200
3-point hitch category		I	II	II-III
Tool type		blades-hammers	blades-hammers	blades-hammers
Blades	n°	24+12-32+16-40+20-44+22-48+24	60-60-72-72	78-84-90
Hammers	n°	14-16-20-22-24	20-20-24-24	26-28-30
Transmission speed	rpm	540	1,000	1,000
Belts	n°	3	5	5
Mechanical offset		•	-	-
Hydraulic offset		◊	•	•
Reversibility		◊	•	•
1000 rpm front/rear gearbox		◊	•	•
Skids		◊	•	•
Wear-resistant sheet metal		◊	◊	-
Toothed counter blade		◊	•	•
Collecting rakes		-	-	-
Pivoting wheels		◊	-	◊

• standard ◊ optional - not available

# Tall-chamber straw choppers

45 to 200 hp – woody material up to a Ø 6 cm



**CHIARA**

## QUALITY RESIDUE MANAGEMENT

Three tall-chamber mulcher models, invincible in any conditions, make up this range that can be coupled with tractors with horsepower in the 45 to 200 range.

CHIARA and TORNADO have been designed with a tall mulching chamber and large diameter rotor for even, quality shredding and excellent discharging of the resulting mulch. This equipment, with high speed and hourly work rates, is used for brush, grass, straw and crop residue management, suitable for maize, cotton, rape, sunflowers and sugar cane.

CHIARA and TORNADO, which are rear-mounted implements, have manual or hydraulic side offset adjustment. CHIARA also comes in a fixed or offset version.



## HEIGHT THAT COUNTS

The tall mulching chamber means the implement can handle a substantial flow of material - even at considerable forward speeds - without detriment to shredding quality. More specifically, CHIARA and TORNADO feature heights of 670 and 720 mm respectively.

## IMPECCABLE SHREDDING

CHIARA has a 168mm Ø rotor measuring 10 mm thick and 4 toothed drive belts. TORNADO has a 194mm Ø rotor measuring 10 mm thick and 5 toothed drive belts.



# High-speed shredding

## CHIARA

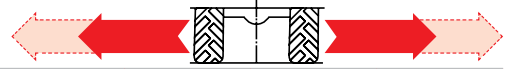

Mod.	MAX cm	MIN cm	MIN cm	MAX cm
160 F	102	55	53	100
180 F	102	55	83	100
200 F	102	55	103	150
230 F	120	70	115	165
250 F	117	70	138	185
160 S	95	55	60	100
180 S	95	55	90	130
200 S	95	55	110	150
230 S	113	73	122	162
250 S	113	73	142	182

## TORNADO

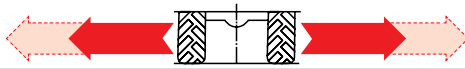

Mod.	MAX cm	MIN cm	MIN cm	MAX cm
220	115	85	115	145
250	128	98	122	152
280	140	110	140	170
310	172	142	138	168

SPECIFICATIONS		CHIARA	TORNADO
Working width	cm	155-185-205-235-255	230-250-280-310
Total width	cm	175-205-225-255-275	250-270-300-330
Weight	kg	620-694-734-798-842	920-960-1035-1125
Tractor power	HP	45-90	60-150
3-point hitch category		II^	II^
Tool type		blades-hammers	blades-hammers
Blades	n°	36+18-44+22-48+24-52+26-60+30	48+24-52+26-56+28-64+32
Hammers	n°	36-44-48-52-60	24-26-28-32
Transmission speed	RPM	540	540
Belts	n°	4	5
Mechanical offset		•	•
Hydraulic offset		◇	◇
Reversibility		-	-
1000 rpm front/rear gearbox		-	-
Skids		◇	◇
Wear-resistant sheet metal		◇	◇
Toothed counter blade		•	•
Collecting rakes		-	-
Pivoting wheels		◇	◇

• standard ◇ optional - not available

# HEAVY-DUTY straw choppers

120 to 300 hp – woody material up to Ø 6 cm



## GEMELLA

### A RANGE FOR HIGH YIELDS

The range of professional mulchers comprises 2 unstoppable models - LEOPARD and GEMELLA - built to meet the growing requests from demanding large farms and contractors.

Developed and conceived to cater for increasingly high yields, intensive use and shredding of unrivalled quality, they can be paired with high-powered tractors up to 300 horsepower.

The very rugged build and HEAVY-DUTY bearings ensure brilliant performance in residue management for crops such as maize, sorghum, sunflowers, straw, cotton and sugar cane, as well as grass and brush, speeding up their natural breakdown process. With its working widths of 4.65 and 6.20 m, GEMELLA can handle large surface areas, drastically reducing the time it is in use.



### HYDRAULIC CENTRAL BLADE

This new hydraulic twin-blade cutting device has been designed to be attached at the rear, ensuring full management of residue in the field, including the uncut strip that escapes GEMELLA's shredding heads. The resulting assembly is teamed with an oil cooling system that uses a fan unit.

### PIVOTING WHEELS: for all-round terrain hugging

Both models can be fitted with rear pivoting wheels to adjust work height and improve manoeuvrability at the ends of the field. If these wheels are fitted, the rear roller must be removed.



### TOOTHED LOWER COUNTER BLADE

For a finer mulch, both models have the toothed lower counter blade mounted on the internal structure inside the hood. With this device, the residue is shredded further, helping speed up the decomposition process.

# The solution to every challenge

## LEOPARD



## GEMELLA

SPECIFICATIONS		LEOPARD ST	LEOPARD DT	GEMELLA
Working width	cm	320	320	465-620
Total width	cm	349	349	502-657
Weight	kg	1,280	1,356	2500-2925
Tractor power	hp	140-180	140-200	120-300
3-point hitch category		II	II	II, III and 4N
Tool type		blades-hammers	blades-hammers	blades-hammers
Blades	n°	68+34	68+34	96+48-128+64
Hammers	n°	34	34	48-64
Transmission speed	rpm	1,000	1,000	1,000
Belts	n°	5	3+3	5+5
Mechanical offset		-	-	-
Hydraulic offset		-	-	-
Reversibility		-	-	-
1000 rpm front/rear gearbox		-	-	-
Skids		◇	◇	●
Wear-resistant sheet metal		◇	◇	◇
Toothed counter blade		●	●	●
Collecting rakes		-	-	-
Pivoting wheels		◇	◇	◇

● standard   ◇ optional   - not available

# The right weapon for a consistently high-quality cut

## A SOLUTION FOR EVERY MULCHING NEED

To achieve unbeatable mulching quality and hence speed up the material's breakdown process, it is essential to choose the right tool for the type of vegetation to be managed.

Depending on the model, MASCHIO GASPARDO offers various tool types in a range of sizes so as to achieve the very best result and meet the demands of farmers and contractors.

Choosing the right tool means uniform cutting and correct mulch consistency are guaranteed every time.



### GRASS AND LAWNS

The best tools for mowing grass are designed to give a clean, even cut and uniform height.

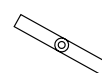

JOLLY



18



19



### SCRUB AND BRUSH

These tools are mounted on multipurpose equipment and allow you to manage vegetation of various kinds: grass, brush, leaves, fibrous and woody stalks, even with sizeable diameters.

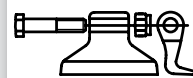

14



15

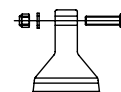

16



### CROP RESIDUE

Straw chopper tools have been designed to handle a large amount of crop residue and achieve a fine mulch. For lighter residues, KIT 03 is ideal as the special blade encourages ventilation, which lifts all the material.



03

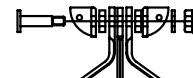

05

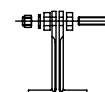

07



### PRUNINGS

The ideal tools for mulchers handling woody material are mainly hammers or knives that have special blades fitted (KIT 10). The tool's shredding action breaks the fibres of woody residues to improve decomposition rates.

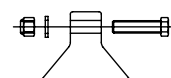

08

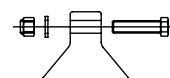

20

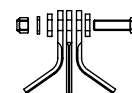

10



21

# The right combination

	BIRBA	FURBA	BARBI	BRAVA - L	BELLA	CORAZZA	TIGRE	GIRAFFA S	GIRAFFA M	GIRAFFA L	GIRAFFA XL	GIRAFFA XXL	BISONTE	BUFALO	CHIARA	TORNADO	LEOPARD	GEMELLA
KIT 03																	●	●
KIT 05															●	●	●	●
KIT 07															●			
HAMMER 08				●	●					●								
BLADE 10				●	●					●								
HAMMER 14						●	●				●	●	●	●				
BLADE 15						●	●				●	●	●	●				
HAMMER 16															●	●	●	●
BLADE 18			●						●									
BLADE 19	●	●						●										
HAMMER 20			●						●									
HAMMER 21	●	●						●										

**GIRAFFA XL**

**BUFALO**





H-7522 Kaposújlak, 095/3 hrsz.  
Tel: (+36)30/500-2050, (+36)30/336-9804  
E-mail: [bedenek@kapos-net.hu](mailto:bedenek@kapos-net.hu)  
WEB: [www.bedenek.hu](http://www.bedenek.hu)