

Haymaking | Fenaison

# BF

Double action sickle bar mower  
Barre faucheuse à double action



AGRICULTURAL MACHINERY  
**enorossi**

ENG-FRA



Your ideas, Our products

# BF

## Double action sickle bar mower Barre faucheuse à double action



The ENOROSI double blade sickle bar mowers reach high working speed without clogging, guaranteeing a precise and clean cut. The inclination angle, during working, ranges from +90° to -45° so they can be used both in ditch cleanings and for vertical prunings.

**They are available in version with rivets (BFT series) or with removable tooth (BFS/BFF series).**

The hitching with the tractor is CAT I and CAT II.

*Les faucheuses à double action ENOROSI permettent d'atteindre une vitesse de travail élevée sans colmatage, garantissant une coupe précise, propre et nette. L'angle d'inclinaison, pendant le travail, varie de +90° à -45° pour qu'elles puissent être utilisées aussi bien pour le nettoyage des fossés et pour les tailles verticales. Elles sont disponibles dans la version avec rivets (série BFT) ou avec doigts démontables (série BFS/BFF).*

*L'attelage au tracteur est de CAT I et CAT II.*

## BF/BFS

### Double action sickle bar mower Barre faucheuse à double action

**Low ecosystem impact.**  
*Faible impact sur l'écosystème.*



**Deflector** which shapes the windrow.  
*Défecteur pour former l'andain.*

**3-belt transmission.**  
*Transmission à 3 courroies.*



Till to 270 cm **working width.**  
*Largeur de travail jusqu'à 270 cm.*



**External shoe** for a better penetration.  
*Coulisseau externe pour une meilleure pénétration.*



Adjustable **sled** on 3 positions.  
*Patin réglable sur 3 positions.*

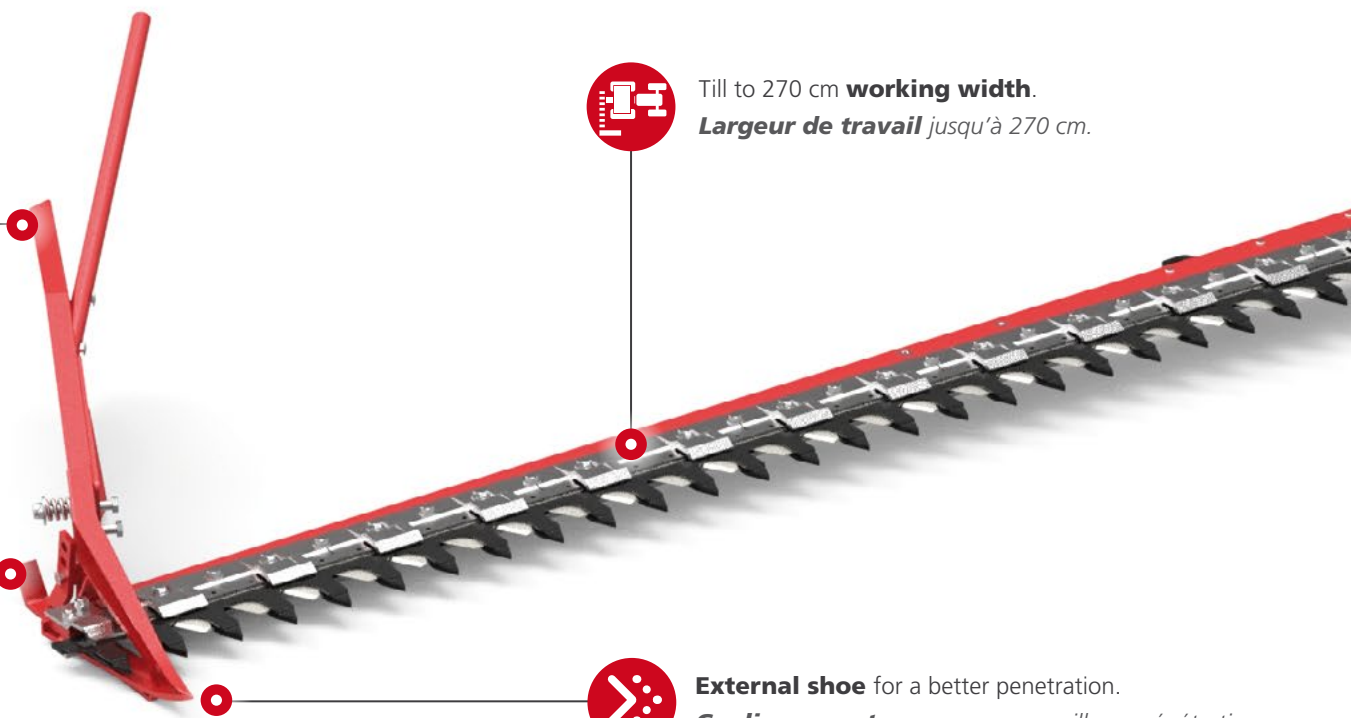



Mechanical or hydraulic **lifting**.  
*Levage* hydraulique ou mécanique.



Lightening **spring**.  
*Ressorts* de compensation.



Belt tensioning **spring**.  
*Ressort* tendeur de courroie.



Mechanical **safety** device.  
*Dispositif* mécanique de **sécurité**.



**Cutting system** suitable on stony ground too, with low cutting residue.  
*Système de coupe* adapté également aux sols pierreux, avec peu de résidus de coupe.



Alternated **single blade**.  
*Lame* simple alternée.

# BFF

## Front hitch version

Version attelage avant



**Front hitch** with PTO.  
**Attelage** avant avec PDF.



Swath-forming **deflector**.  
**Défecteur** pour former l'andain.

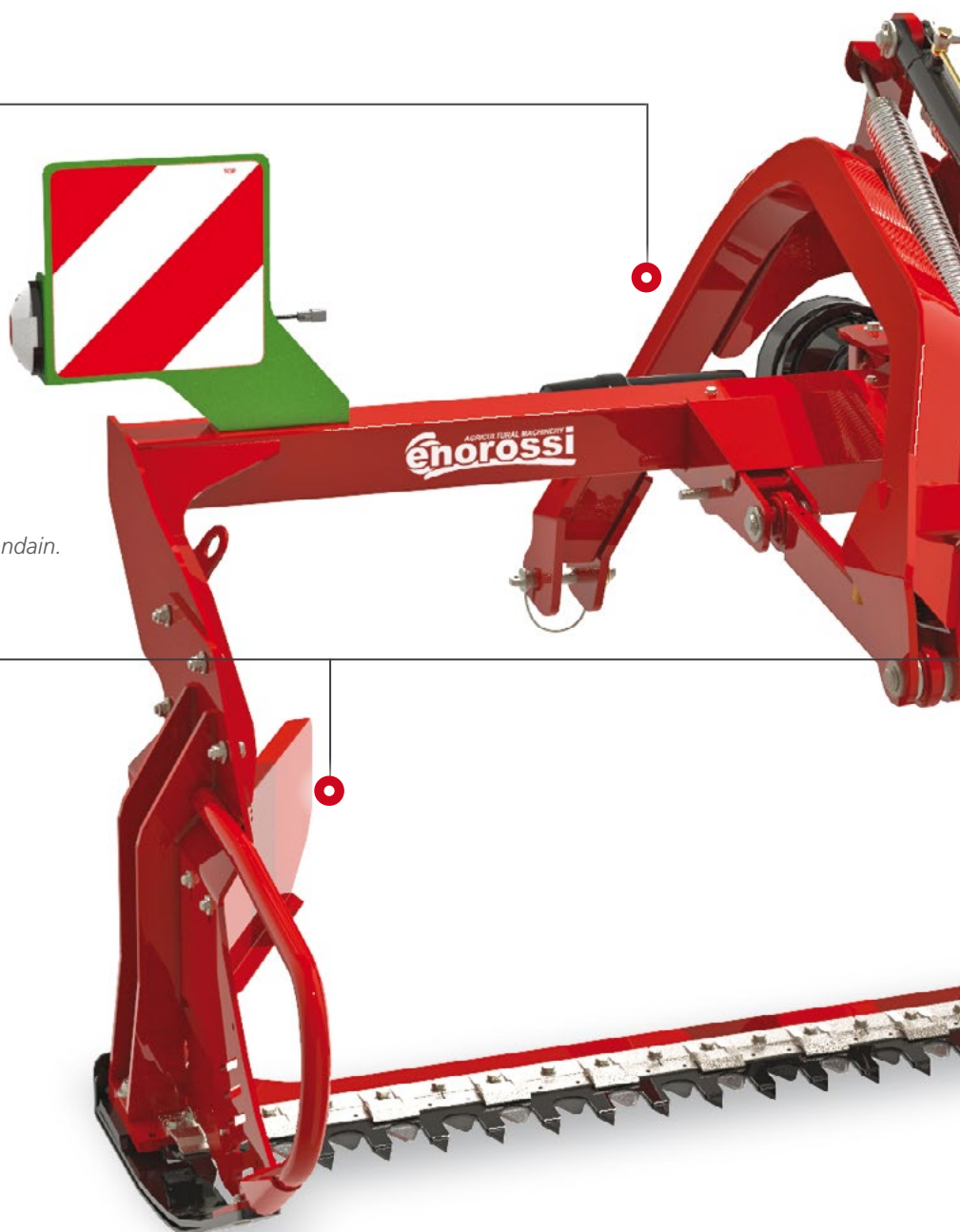



Anti-breaking and lateral oscillation **"Pull Back" system.**  
**Systeme anti-casse "Pull Back" et oscillation laterale.**

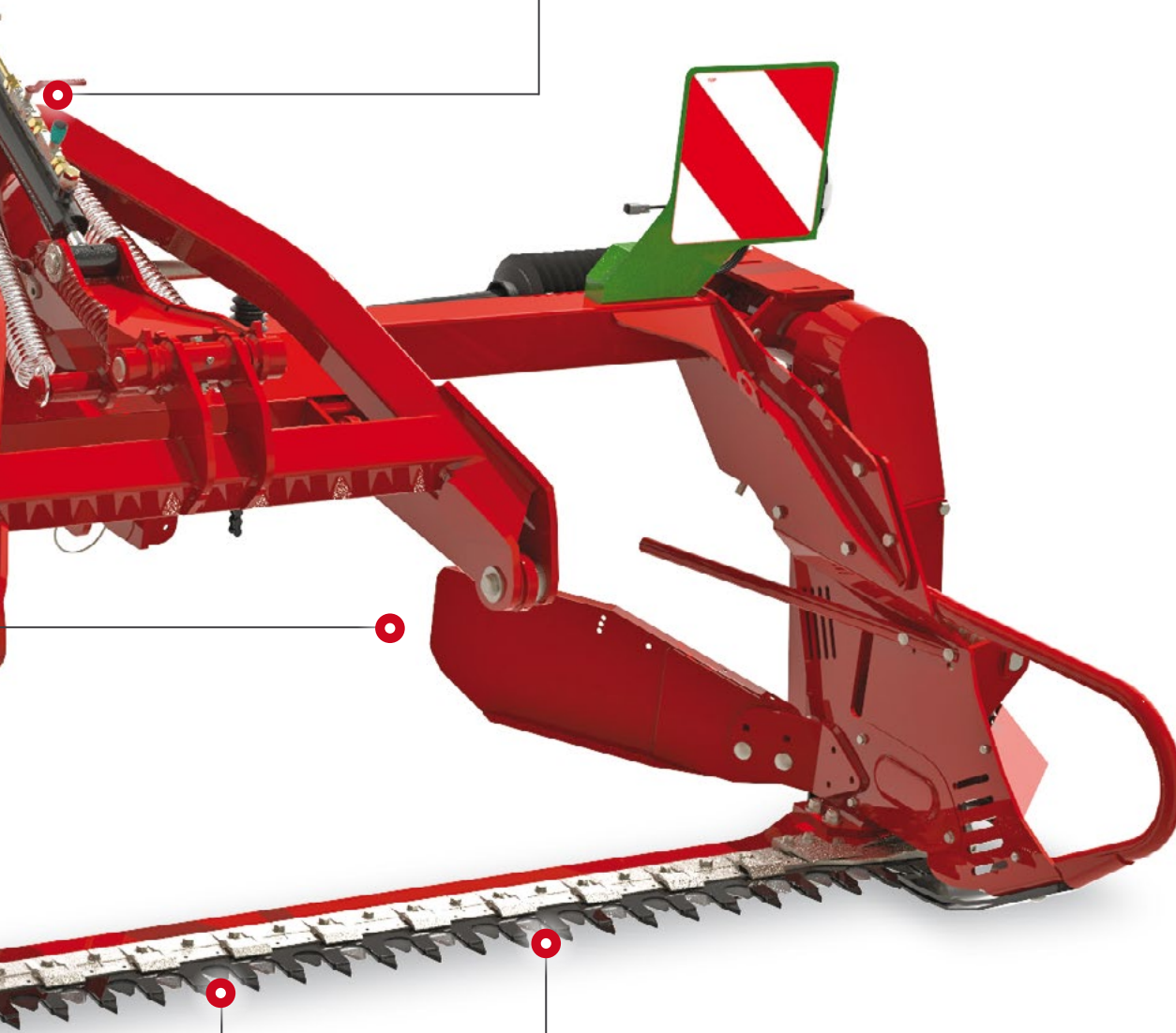

Alternated **single blade.**  
**Lame simple alternee.**



Till to 270 cm **working width.**  
**Largeur de travail jusqu'à 270 cm.**

# BF-BFS

## Double action sickle bar mower

Faucheuse à doigts double lame



Blade section.  
Section de lame.

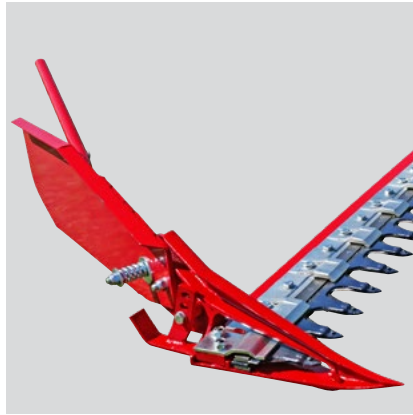

Metal deflector for windrow formation.  
Déflecteur en acier pour la formation de l'andain.

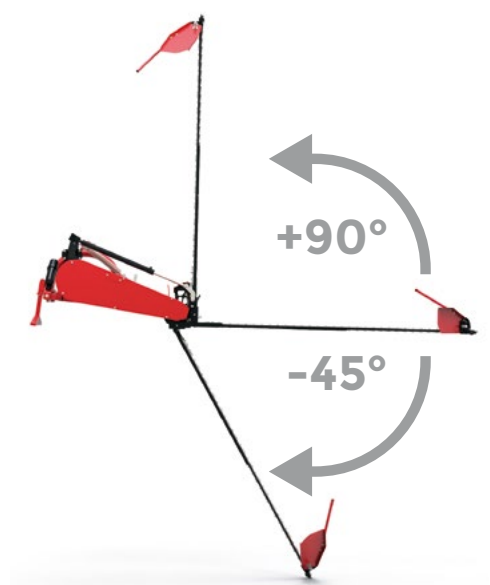

Maximum inclination during working  
from +90° to -45°.  
Inclinaison maximale pendant le travail de  
+90° à -45°.



Control support in pressed steel with  
cemented bushings.  
Support de commande en acier embouti  
avec bagues cimentés.



Safety release in case of collision with  
obstacles.  
Déclenchement de sécurité en cas de  
collision avec des obstacles.





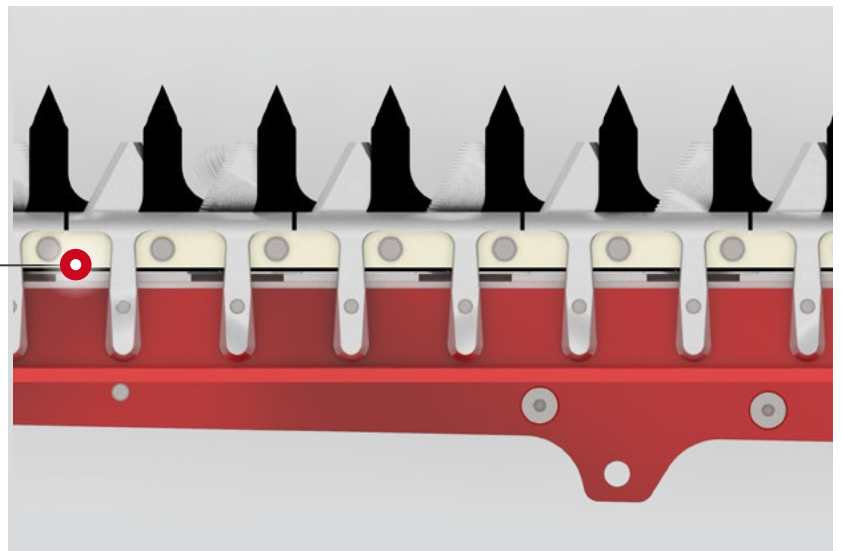
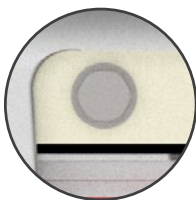







### BFS/BFF series with bolted guards

Version BFS/BFF avec doigts démontables





# Technical Data / Données techniques

	BFT 135	BFT 150	BFS 165	BFS 180	BFS 210	BFS 240H	BFS 270H	BFF 270H
 <b>Working width</b> Largeur de travail	135 cm 4.5 ft	150 cm 5 ft	165 cm 5.5 ft	180 cm 6 ft	210 cm 7 ft	240 cm 8 ft	270 cm 9 ft	270 cm 9 ft
 <b>Cutting height min.</b> Hauteur de coupe min.	3 cm 1,18 inch	3 cm 1,18 inch	3 cm 1,18 inch	3 cm 1,18 inch	3 cm 1,18 inch	3 cm 1,18 inch	3 cm 1,18 inch	3 cm 1,18 inch
 <b>Working speed</b> Rapidité de travail	8-12 km/h 5-7.5 Mph	8-12 km/h 5-7.5 Mph	8-12 km/h 5-7.5 Mph	8-12 km/h 5-7.5 Mph	8-12 km/h 5-7.5 Mph	8-12 km/h 5-7.5 Mph	8-12 km/h 5-7.5 Mph	8-12 km/h 5-7.5 Mph
 <b>Hitch</b> Attelage	Rear 3 points hitch / Arrière, attelage 3 points							Front PTO PDF avant
 <b>Minimum power required</b> Puissance minimale requise	20 HP	20 HP	35 HP	35 HP	35 HP	50 HP	50 HP	70 HP
 <b>Weight</b> Poids	195 kg 430 lbs	200 kg 441 lbs	256 kg 565 lbs	264 kg 583 lbs	287 kg 634 lbs	305 kg 673 lbs	322 kg 711 lbs	530 kg 1170 lbs
 <b>Mechanical safety device</b> Dispositif mécanique de sécurité	•	•	•	•	•	•	•	•
 <b>Anti ripple rod</b> Tige anti-ondulation	•	•	•	•	•	•	•	•
 <b>Blade protection</b> Protection de la lame	•	•	•	•	•	•	•	•
 <b>Complete spare blade</b> Lame de rechange complète	•	•	•	•	•	•	•	•
 <b>Cardan</b> Cardan	•	•	•	•	•	•	•	•
 <b>Light kit</b> Kit feux	-	-	-	-	-	-	-	•

OPTIONAL / EN OPTION	BFT 135	BFT 150	BFS 165	BFS 180	BFS 210	BFS 240H	BFS 270H	BFF 270H
<b>BFT hydraulic lifting*</b> Levage hydraulique BFT*	☒	☒	-	-	-	-	-	-
<b>BFT mechanical lifting**</b> Levage mécanique BFT**	☒	☒	-	-	-	-	-	-
<b>BFS hydraulic lifting*</b> Levage hydraulique BFS*	-	-	☒	☒	☒	-	-	-
<b>BFS mechanical lifting**</b> Levage mécanique BFS**	-	-	☒	☒	☒	-	-	-

• Standard / Estándar ☒ Optional available / Disponible En option - Not available / Non disponible

\*Weight / Poids: 16 kg \*\*Weight / Poids: 11 kg

Design and/or specifications are subject to change without notification.  
Enorossi se réserve le droit de modifier les caractéristiques et les spécifications techniques à tout moment et sans préavis.



An aerial photograph of a vast, lush green field, possibly a meadow or a large agricultural plot. The grass is dense and vibrant, with some lighter green patches interspersed. The text "Your ideas, Our products" is centered in the middle of the image in a clean, white, sans-serif font.

Your ideas, Our products

## Our Range / Notre Gamme



**Mowers**  
Fancheuses



**Hay Tedders**  
Girofaneurs



**Rotary Rakes**  
Giro-andaineurs



### HAYMAKING FENAIISON



**Hay Rakes**  
Rateaux soleil



**Balers**  
Presses à balles



**Bale Wrappers**  
Enrubanneuses de balles



**Disc Cultivators**  
Cultivateurs à Disques



**Fertilizers**  
Epandeurs d'engrais

### FARM AGRICULTURE



### IMPLEMENTS OUTILS



**Front Loaders**  
Chargeurs Frontaux



**Rear Scraper Blades**  
Lames Niveleuse



**Backhoes**  
Pelles-Rétro

AGRICULTURAL MACHINERY  
**enorossi**



Your Enorossi

**BEDENEK és TÁRSA Bt.**



H-7522 Kaposújlak, 095/3 hrsz.

Tel: +36-82/713-274, +36-30/336-9804

E-mail: [bedenek@kapos-net.hu](mailto:bedenek@kapos-net.hu)

WEB: [www.bedenek.hu](http://www.bedenek.hu)

Via Cortonese, 36 - 06019 Calzolaro di Umbertide (PG) - ITALY

+39 075 930 22 22 - +39 075 930 23 28

[info@enorossi.it](mailto:info@enorossi.it) - [www.enorossi.it](http://www.enorossi.it)